

Paul A.Murad<sup>1\*</sup>, Morgan J.Boardman<sup>1</sup>, John E.Brandenburg<sup>1</sup>, Jonathan McCabe<sup>2</sup>

<sup>1</sup>Morningstar applied physics, LLC VIENNA, VA 22182, (UNITED STATES)

<sup>2</sup>Orbital Technologies Corporation, Madison, Wisconsin 53717, (UNITED STATES)

E-mail : pm@morningstarap.com;  
mb@morningstarap.com;  
jb@morningstarap.com;  
jonmccabe@orbitec.com

Received: June 27, 2012

Accepted: December 16, 2012

Published: March 30, 2013

## The morningstar energy box- part redux

### Abstract

The morningstar energy box is a revolutionary derivative based upon both the searl and the russian device by godin and roschin. The game-changing technology is similar to a mechanical cage by the russians, laminated rollers per searl and a unique main ring with ferromagnetic fluid to enhance electrical and magnetic properties. The russians made several serious claims that created a weight loss when spun in one direction and gain when spun in the opposite direction, and generated discrete magnetic walls. Surprisingly the energy box found similar phenomenon. The energy box in an early test only lost 2 to 5 pounds of its 190 pounds at steady-state. During transient rotation, weight change dropped as much as 20 to 40 pounds using voltages as large as 120 volts. The device was changed to increase voltage to a maximum of 325 volts. During these last test series, the device with no voltage, unexpectedly showed a steady-state 14-pound weight reduction or 7.3% and a transient loss of 12% of the total weight. Clearly we observed nonlinear energy box phenomenon comparable to the russian claims. A possible objective of the device will be to develop an advanced follow-on energy variant for an advanced propulsion system.

### Keywords

Weight reduction; Electric field; Magnetic field; Voltage; Magnetism; Searl; Godin; Roschin; Poynting vector; Vorticity.

---

#### \*Corresponding author's Name & Add.

Paul A.Murad  
Morningstar applied physic, LLC  
VIENNA, VA 22182, (UNITED STATES)  
E-mail : pm@morningstarap.com

## INTRODUCTION

There are several controversial mechanisms especially when they supposedly may claim activity similar to a perpetual motion machine. Due to disbelieve in such situations, machines that perform over a unity of one are normally discounted. This rationale may be a technological flaw to not seriously examine these unusual devices. Some devices that are controversial regard efforts of searl<sup>[1-3]</sup>, and by godin & roschin<sup>[4-6]</sup> with significant claims about phenomenon that have either produced unusual electromagnetic fields or the gain or loss of weight. If successful and if real, such devices may implicate new forms of 'green energy' or some advanced propulsion capabilities to include spacecraft<sup>[7,8]</sup>. The problem is to investigate these claims with a sane rational approach to identify a potential significant game-changing technology that may create advanced propulsion or energy. The energy box clearly

falls within this domain and warrants continued investigation.

## RESULTS AND DISCUSSION

### Searl device

The idea proposed by John Searl<sup>[1-3]</sup> has created significant controversy. The basic idea of his device is that cylindrical magnets will interact with a ferromagnetic bar of material. These magnets will diametrically approach a certain displacement from the bar. Searl's contribution bends the bar into a contiguous ring so that the individual sleeve followed by a dielectric material externally concentric by an aluminum sleeve. The dielectric provides a gate magnets 'hunt' and 'peck' in a circular arrangement with an equal azimuthal increment with respect to the ring. The rollers actually stay above but do not contact the ring surface. His notion suggests that all of the magnets have

either all south or all north polarity. The other contribution by Searl is that the rollers and rings are laminated with specific materials. For the roller, they consist of a central core that includes an intense magnet. These are inserted in a copper for electrons; other roller materials also provide electrons. The ring has a similar laminated arrangement where the magnet is on the exterior portion of the ring and aluminum within the interior ring. Other elements to include iron can also be used. Searl identifies the law of squares or the *magic squares*<sup>2</sup> but we found there is basically no real science to validate this concept.

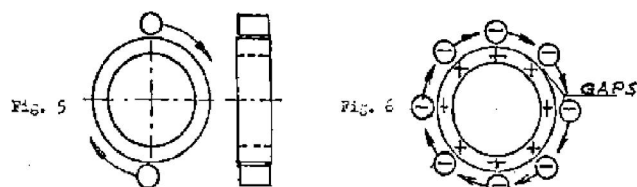

**Figure 1 :** The rollers operate around the ring with a parity of the pole magnets.

Rings will achieve a magnetic/mechanical resonance that produces a rotation rate as the rollers move quickly about the ring. Some felt that the roller rotation rate motion is the same as the surface motion on the ring whereas another view implies the roller rotation rate moves actually faster by a factor of six. That means the rollers rotate faster than the motion expects around the ring. To generate electricity, passing rollers move through a transformer capture device that generates electricity by cutting the roller lines of its magnetic field. In a different variation from the theme, these sections could be charged to create an electric signal that allows induction for the roller's rotation. Very little evidence has identified the amount of current generated by this device. Finally, Searl suggests that the device may have three concentric sets of rings and rollers<sup>[3]</sup> but no evidence has ever shown any working apparatus with more than a single ring.

Considerable information claims that Searl may have generated some devices that actually lifted to high altitudes. Nevertheless, these comments did not provide real evidence for these claims and are a principal source of controversy especially why one would want to lose such a complex device in the first place.

### The brown device

Before his demise, dr. Paul brown<sup>[4]</sup> created a searl device supposedly the size of a telephone book. Rollers were in even pairs and had a specific radius of the roller radius to the diameter with the ring. Test results suggested the device was unstable and created about a megawatt of electricity. Wires started to glow and magnets were so overheated that they caught fire before the system was destroyed. Not much information is available about this

machine. However, if the magnets became hot, they would exceed the curie temperature and the magnets should have lost their magnetism. Consequently, the device rotation should have ceased.

### The Russian Godin and Roschin device

Roschin provided an initial device that resembled a searl system to demonstrate feasibility. Godin and Roschin<sup>[5-7]</sup> are Russian scientists that created a comparable electromagnetic technology. They made a similar ring with several hundreds of pounds of magnets using selenium. Rollers were not concentric but actually cylinder slabs for each of these materials. Rollers were also constrained to a mechanical carousel or armature that oriented the location of the rollers as well as the spacing from the surface of the ring. Other variations by the Russians are that the rollers had used radial magnets meshed between the rollers and the ring. If this worked successfully, rollers would rotate per the linear spacing of the ring where the magnets meshed like gear teeth.

This device, reported<sup>[6]</sup> at an AIAA meeting in 2001, claimed the device self-accelerated, that it rotated by itself. A 7 kW generator was used to generate electricity. The device was charged on the exterior of the rollers to 20,000 volts. It is not clear how this voltage was applied. When the device rotated at 600 rpm, the approximate weight of the 375 kg armature lost 35% of its weight. They claimed at this time, the temperature decreased. When rotated in the opposite direction, the device gained 35% of weight at 560 rpm. Moreover, the system produced magnetic discrete walls that were at several distances away from the device. Finally, the system also had a smell of ozone.

Unfortunately, the authors stated that in 1993, the device was torn apart supposedly to obtain money for support funds. For example, the magnets were very costly. This was a crucial time during the economic collapse of the Soviet Union. For this reason, when the findings were presented, there was not much of any encouraging response from the participants of the meeting proceedings.

They were able to create a second heavily modified device. Unfortunately this second device was not successful. A third attempt was produced but has not provided any new or additional information about the Godin and Roschin device. At face value the primary issue is that if the temperature decreased with the weight loss, this would constitute an unruh-like effect. However, their oral report does not mention temperature increases commensurate with weight increases per the technical paper.

The Russians had several different theoretical views regarding how their device worked. The main idea is that angular momentum can convert linear momentum. This may sound trivial; however it works in terms of a wheel in a bicycle, a car or a locomotive. The notion<sup>[8-10]</sup> here is

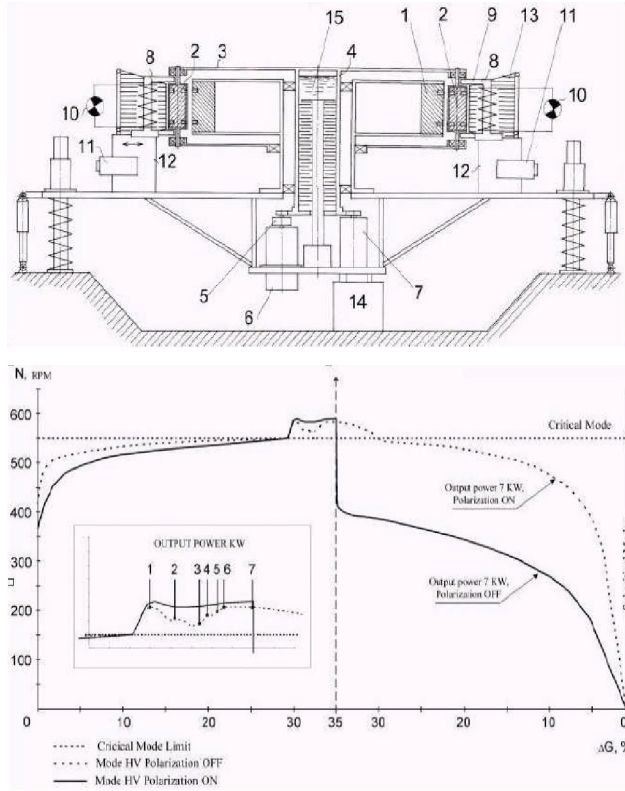

**Figure 2 : The rotating mec supposedly generated self acceleration as well as very significant phenomena.**

that a von karman vortex street provides this effect. Unfortunately the problem in this particular situation is not obvious. Each odd vortex would rotate in one-spin rotation while even vortices rotate in the opposite spin. Moreover, the length of these vortices may not be of even lengths for specific conditions. Results are shown in the following figure.

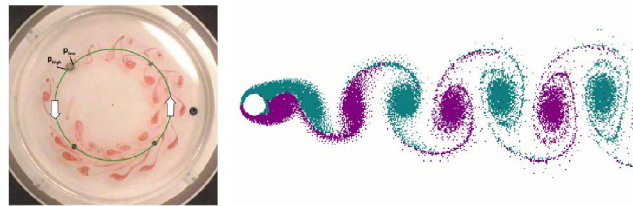

**Figure 3 : A vortex street has specific fluid geometry. The russian notion may be promising on this basis for certain pairs of vortices that act on the ring and the opposite vortices in the rollers.**

**The Morningstar energy box**

The name “Energy Box” is definitely a misnomer. The original purpose of the device was to create a magnetic motion drive. Unfortunately this did not occur when experiments revealed that the device could alter its weight. This was unexpected. The unusual operation of this device is that the rollers move within a three-dimensional magnetic field in a circular kinematic trajectory that differs from an axisymmetric electrical motor because of the electromag-

netic field trajectory.

This revolutionary variant is based upon at least three possible theoretical principles. These possibilities are:

- **Angular momentum**- the idea is to change mother nature by transferring angular momentum into linear momentum possibly similar to the russian motives.
- **Gravito-electro-magnetism (GEM<sup>[11]</sup>)**- this notion uses a poynting vector force induction based upon the roller design that act like magnetic dipoles, and
- **Retarded potentials**- the ring acts as a roller reflection plane on the ring. If the time is retarded or through magnetic hysteresis, it is possible that the image and subsequent forces from one roller may attract the adjacent roller to create self-acceleration.

The first approach would allow angular motion to induce linear motion using interactions with magnetic and electric fields. The second approach initially looks at a magnetic roller/capacitor around the ring in figure 4. When roller motion is started, an electric field is created by maxwell-heaviside’s equations. If the magnet is longitudinal and the electric field in the roller is radially oriented, the poynting vector, which is the cross product between the electric and magnetic fields, would create a force to induce motion. John searl’s use of dielectrics tends to act like a capacitor, thus it is obvious that the searl roller creates such a poynting vector effect. Additionally, we have found a derivation for the Poynting field conservation that offers additional effects dependent upon separate magnetic and electric fields. The Poynting field<sup>[12]</sup> looks very promising but requires further investigations. The Poynting field is:

$$\bar{S} = \frac{1}{\mu_0} (\bar{E} \times \bar{B}) \tag{1}$$

And the conservation equation is:

$$\mu_0 \left[ \frac{1}{c^2} \frac{\partial^2 \bar{S}}{\partial t^2} - \nabla^2 \bar{S} \right] = -4\pi \left[ \rho_m \nabla \times \bar{E} - \rho_e \nabla \times \bar{B} + \frac{1}{c^2} \frac{\partial}{\partial t} (\bar{J}_e \times \bar{B} + \bar{E} \times \bar{J}_m) \right] + \mu_0 \nabla \times \nabla \times \bar{S} \tag{2}$$

Where  $S$  is the Poynting field<sup>[13]</sup>,  $E$  is the electric field,  $B$  is the magnetic field,  $J$  represents currents,  $\rho$  is a source term with subscripts are for  $e$  with electric and  $m$  for magnetic fields. This also provides insights into gravitational forces in a recent publication<sup>[12]</sup>.

The retarded potential looks at the electric and magnetic field images in the ring created by the roller. If these images in the surface plane could be delayed, say due to high rotation about the carousel that aligns the rollers, the images may drag the next roller to cause linear momentum and self-acceleration. It is conceivable that the revolutionary performance of the Energy Box may use combinations of each or all of these theories.

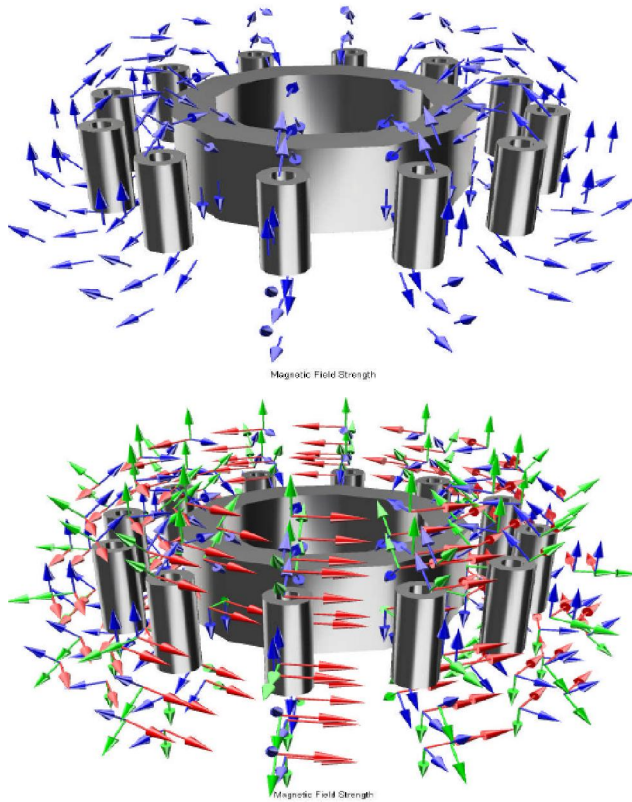

**Figure 4 :** The top figure is with no rotation and the bottom uses rotation. Blue arrows are the magnetic field, Green is the electric field and the red is the Poynting field to drive the rollers with motion.

## EXPERIMENTAL SECTION

### The Russian Godin and Roschin device

The device operates with rollers similar to sear's design and the design of a ring, while a cage is used as a carousel similar to the russian device. The ring in this figure is a laminated device with different rings to enhance the electric and magnetic properties and how this will interact with the rollers. Moreover, in lieu of using magnets within the ring, Hymu-80 material in the ring contains a copper reservoir for a ferromagnetic fluid. In addition, rollers have a passageway to allow air motion to cool the magnets and hopefully prevent the magnet fire problem seen by brown. Hymu-80 material is also used as the magnetic core of the rollers and the core is placed in concentric angular neodymium magnets. This is generally followed by a copper sleeve and isolated aluminum sleeve. Thus, the energy box has similar components with these effects, which includes use of the most favorable characteristics gathered from several serious investigations. Components for these elements are seen in figure 5.

The system used to determine information includes various components. Measurement Specialties Inc. manufactures the six load cells with part number FC2231-0000-0100-L. The load cell is capable of 0-100 lbf with out-

puts from .5 to 4.5 volts. These load cells were placed on the bottom of the cabinet to minimize any magnetic effects from the rollers. Moreover, cables were used to minimize magnetic effects from distorting electrical signals during the operation. AlphaLab Inc. provides a magnetometer using part number DC Gaussmeter M1ST with a range of 0 to 20,000 gauss; this was increased using a modification by the developer to 30,000 gauss. The Motenergy (formerly Mars Electric Inc.) motor is a 48 V brushless DC motor capable of 5-10 kW or a maximum of about 6.7 HP with a rotation rate of 0 to 5,000 rpm. Compact Instruments Tachoprobe A2108 provides a laser tachometer to determine rotation levels capable of 80 to 6,000 rpm. The National Instruments SCXI 1600 data acquisition system was used for all measurements. The configuration contained 32 channels of analog to digital conversion that was additionally fitted with an SCXI 1102 32-Channel Thermocouple/Voltage Input Module as well as an SCXI-1102C 32-Channel Amplifier Module. In addition, to overcome noise in the data, a relaxation filter was also used. The assumed actual weight is approximated by .025 times the new experimental measured weight added to 0.975 multiplied by the weight at the previous time step to decrease frequencies higher than the Nyquist frequency sampling rate. This provides a reasonable weight distribution as a function of steady-state and rotation rate changes.

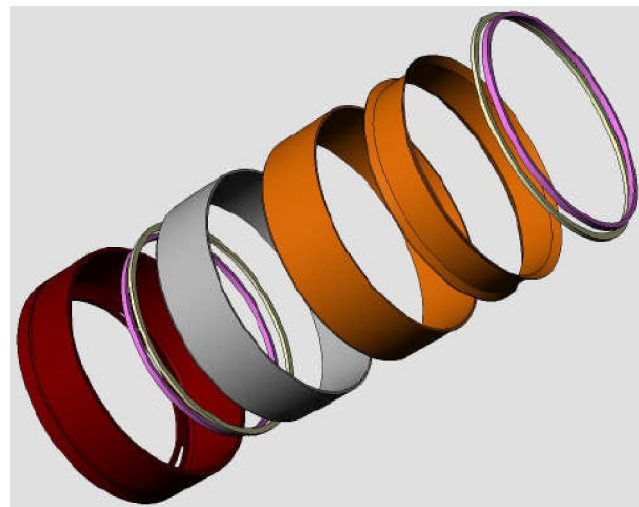

**Figure 5 :** The laminated ring graphically shows with the actual ring and spindle to drive the carousel. Hardware for the carousel also includes the motor and support drive.

Four different types of rollers were manufactured. The interaction of these rollers depends upon the strength of the magnets as well as performance. The ability of the rollers to hunt along the ring is also crucial. Some of these concepts were found unworkable based upon how they would be anchored to the carousel. In general these rollers used a core that consisted of Hymu-80. The green color represents a copper sleeve and an aluminum sleeve



that is gray that does not have electrical contact to the other components within the roller by the yellow separate sleeve. Magnets in the central core were small segments because it was difficult to obtain magnets within the roller geometry. The purple objects are larger magnets that enhanced the magnetic pole of the roller. These magnets generally were strong enough to generate a pull of 69 pounds per magnet. This created quite a bit of difficulty in terms of handling these rollers that are shown in figure 6.

In a phone conversation with devon tassen14, the recommendation was made to enhance the poles of the rollers. This advice was correct. The successful roller used larger magnets at the poles compared to the rollers that used smaller magnets. The final selection for the roller design used a turbine like arrangement that replaced the plastic sleeve. This would allow an air passageway between the copper and aluminum sleeves. If the magnets were too hot, this air would provide a modicum of cooling and prevent problems. In the experiments, a question was raised if these turbines could generate aerodynamic lift. We used tape over these accesses to block any air passage and there was no change in performance. If this were an important conclusion, the lift would go in one direction to decrease weight and probably add weight in the opposite direction. No clear-cut demarcation occurred. If there was weight loses or gains, they occurred at specific situations based upon rotation rates or different voltages.

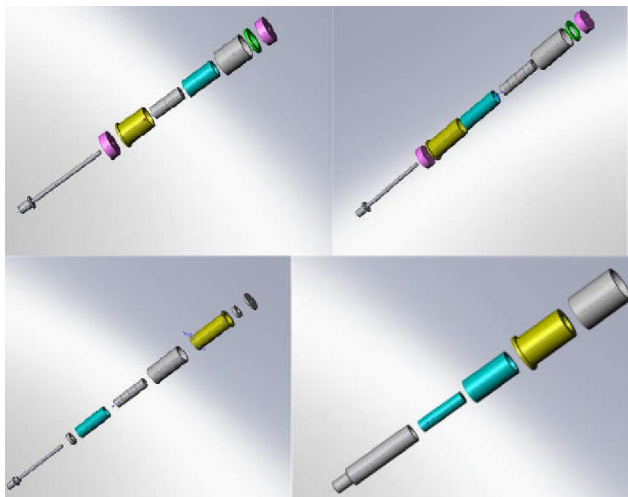

**Figure 6 :** Four different roller configurations were initially fabricated to test capabilities.

Ivan Kruglak provided significant insights on these devices and the performance of the godin and roschin device. Kruglak<sup>[15]</sup> stressed that they used a planetary gear relationship to enhance roller rotation. One approach used by the russian device was that small magnets were drilled and physically meshed within both the rollers and the ring. This was to generate a gear-like tooth mesh action to ensure that roller motion about the spin of the rollers. Some

collars used on the roller were altered to allow for the creation of small-embedded magnets in a radial direction. This was in addition to the larger magnets. No small magnets were incorporated in the ring. After tests, there was no great difference in results with these modifications. If anything, the small magnets would be ejected from the roller due to the strong centrifugal force acting away from the center of the carousel. To our surprise, the small magnets were not ejected radially but were found located on the ring considering that the rollers move about 100 g's of acceleration. This surprisingly suggests that the magnetic attraction of the ring with its hymu-80 material and ferromagnetic fluid acted far stronger than the centrifugal motion.

The last detail is a capacitor that is imbedded within the plastic turbine. This in turn is connected to the large bottom magnet to the aluminum sleeve. The connection through this magnet allows electrical continuity throughout the entire roller and the aluminum acts similar to a capacitance to create an electric charge to induce a poynting force.

There are several basic options for tests that exist. Rollers can be either 12 or 24 in the carousel, four different versions of rollers were examined and the device may rotate clockwise or counter-clockwise. There are several different voltages usually from 0, 60, 120, 180 and 1,000 voltages with plus or minus charges and the amount of ferromagnetic fluid can be at 0, .50, to 1.00 levels. This easily results in a spectrum of at least 120 test variations.

Based upon the rationale for a device to generate electricity, self-acceleration is the highest desirable phenomenon. To date we have not observed this phenomenon with any certainty. However, several unusual effects were observed and documented under controlled laboratory conditions. Results clearly demonstrate that this is a very non-linear device.

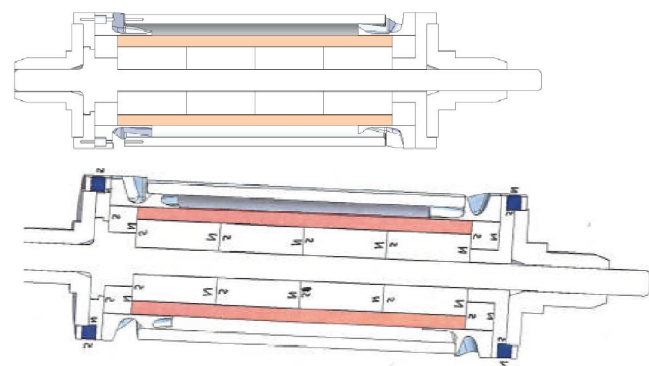

**Figure 7 :** The selected roller design with and without using small radial magnets at the collars of each roller end are seen with no basic difference in performance.

The first investigation was to examine the magnetic field from the device. Results are a function of rotation rate and radial distance. Maximum field strength is located at

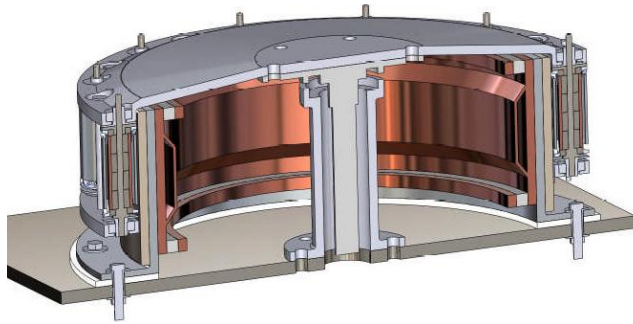

**Figure 8 :** This is the integrated assembly that resides on a base support plate

9.5 inches for the rollers' position in the carousel. If the roller magnets were set at alternating poles, the strength of the magnetic field was significantly reduced. Reverse polarity of the alternating rollers, in effect cancel or compete with adjacent rollers. On this basis, the rollers were used in the same polarity to maximize field strength.

**Fig. 5 I-B2 Gauss Vs. RPM at 9.5"**

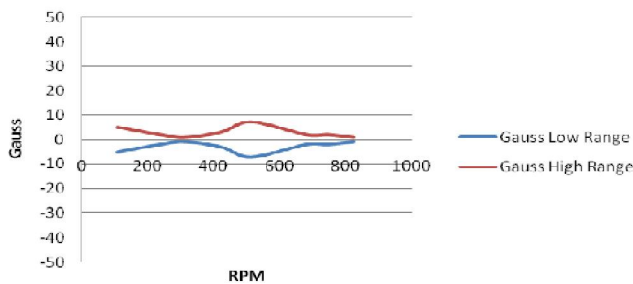

**II-A1 RPM Vs. Gauss at 9.5" Detail**

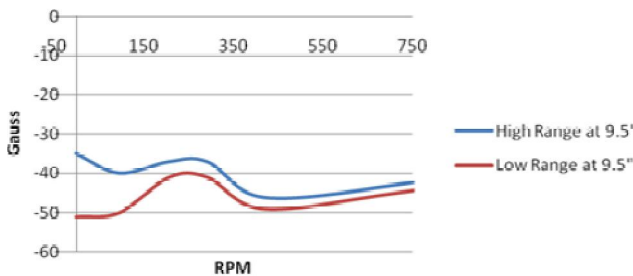

**Figure 9 :** The magnetic field response shows the polarity of the rollers.

In general there was no obvious increase in the magnetic field as a function of rotation rate. However, some disturbances showed at considerable radial distance from the device. Later, it was apparent that the magnetic field would move radially outward at a greater distance to increase carousel velocity, it is possible that these 'moving' magnetic walls are radial shells. Here, some sudden increases for magnetic walls show discrete changes in the field. This is unusual in that one would normally expect the field to be continuous and not discontinuous in the magnetic field. This is similar to some of the effects observed by the russians.

Because of the limited laboratory spacing, we could only

measure two or three walls from the device. Also there are a number of other metal objects in the cramped test lab, which may supply the magnetic fields. Moreover, the magnetic walls appear like shells that increase radially as the rotation rate increases.

Using magnetometers, the walls are not linear barriers as the russians imply. Here, the walls follow a parabolic curve similar to expected trajectories from the magnetic lines of force. The difference is that the russian device could have had a significantly stronger magnetic field than in this device. The reason these walls are important is that the magnetic field movement could be used to harvest electrical energy away from the machine.

**III-A2 RPM and Gauss over Distance  
Incomplete Data**

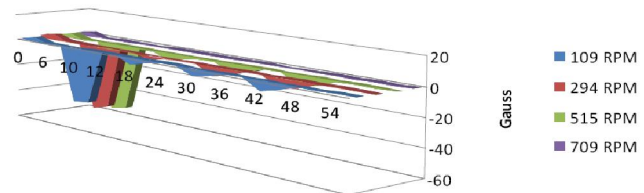
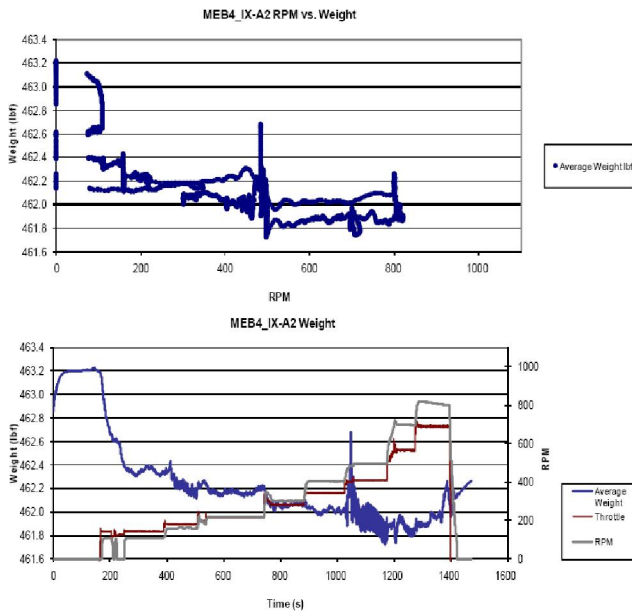

**Figure 10 :** The walls showed some radially displaced locations from the mechanism. These walls would increase with increases in rotation rate.

When the device was originally examined with two thermocouples to give a measure of temperature, there were very unusual responses that varied at different rotation rates. However, some of the instrumentation was incorrect and when grounded, the thermocouples did not show significant temperature variations together with weight increase or decrease. Thermal energy is driven by the drive shaft and a significant amount of electrical power from the motor generates conduction heat transfer. This creates a background noise affect compared to defining an unruh effect so no particular relationship was identifiable for temperature decreases with weight losses or gains. In fact godin later mentioned that there was no real trend to support unruh-like relations.

Regarding weight, bathroom scales initially estimated that there was a change in the device's weight. Some resulting judgments looked at weight changes based upon considerable vibrations that moved during rotation changes. Six load cells were used to determine weight responses. These generated weights that in some situations lost or increased by as much as 20 to 40 pounds. The device, minus the cabinet and instrumentation, would weigh about 190 pounds. The results would be examined where weight was measured against rotation rate. This strongly depended upon varying conditions. However, these results showed specific regions where the rotation rate occurred during a resonance.

Results in figure 11 show rotation rate as a function of time. In this graph, rpm shows a staircase step history. In addition, a smell of ozone was detected when the carousel was removed from the drive mechanism.



**Figure 11 : A typical weight reduction case occurred with resonances at 480 and 810 rpm.**

Results from the first three series validated some of the ideas about the russian device; we saw unusual results that showed increases or decreases in weight but at a smaller magnitude compared to the russian claims. A fourth test series of the energy box was performed approximately two months later after these tests. The new test objective was to modify the rollers to use capacitors capable of holding 1500 volts compared to the original capacitors that only held 100 volts. This would be used to validate the poynting vector approach to increase the force of the rollers by at least a factor of ten.

Real world tests usually provide unexpected situations. These tests had clearly defined reasonable objectives. One co-author established that the capacitor for the lower voltage was really not required during the first three series. This was debated because voltage differences in the rollers could not be sustained; hence, capacitance was required. At higher voltages, several rollers lost their charge because the space between the rollers and the ring formed by an electric arc resulting in a short circuit. This limitation only allowed the device to reach an upper voltage of, say 325 volts before the roller voltage would discharge. In other words, if the device was to achieve a charge of 1,000 volts, the spacing between the insulated rollers and the ring should be increased. This raises questions of how a searl device could operate and sustain a voltage difference or how the russians used 20,000 volts? In other words, short circuits may become routine regarding conserving voltage.

In many postulated theories, the retarded potential was considered as a low probability. Unfortunately, the device was fully assembled and dormant for several months. In the past, the carousel and rollers were disassembled from the ring. Here, the carousel and rollers did not move. This induced magnetic imprints within the ring despite that the hymu-80 material was not supposed to maintain a sustained magnetic field. Moreover, searl indicated that the ring should use imprinting magnets within the ring. By residing in this position for several months, this imprint naturally occurred and this created unexpected events compared with the other series. When spun by hand, the carousel coasted in a relatively smooth fashion. However, after it moved in a particular direction, the carousel would stop and move a small amount in the opposite direction before stopping again. This was unexpected. The rotation was about 10 degrees in azimuth regardless of clockwise or counter-clockwise direction. This effect of ring imprinting tends to support the idea about the hypothesis for a retarded potential.

One of the investigators suggested the device would overcome the strange magnetic effects by rotations above 300 rpm. This effect would persist regardless of rotation rate. When voltage was increased, the device would act as a normal device. This meant that rotation was smoother than previous test series where only a very small weight change was observed in either direction. This was disappointing because this demonstrated that we could not duplicate behavior seen during the other three series. These new trials established experimental uncertainty that reached about .1 or .2 pounds of weight. In a majority of runs, the device would lose or increase weight by about 2 pounds. These weight changes were within 1% considering the 190 pounds of the device without the weight of the cabinet, battery, and charging power supplies. Results were therefore ignored as not being considered as notable.

In addition to the change in the capacitors, the brake drive was also removed for decelerating the electric motor. When 1,000 rpm was reached and power was withdrawn, the carousel coasted for 37 to 39 seconds before stopping though it only took 20 seconds during the prior three test series with the brake. As previously mentioned, the carousel always stopped and reversed direction before finally coming to a rest. When the weight versus rpm data was examined, departures that were once seen at resonance locations in previous tests were found considerably diminished because of the ring imprinting. Data showed some resonance locations but the amplitude was not as prevalent. If power was removed at 1,000 rpm, the weight history as a function of the decreasing rpm showed a sinusoidal response that peaked at different locations for different voltages or rotation directions as shown in fig-



ure 12. This did not seem to show any disparity when the rpm reached resonance thresholds. Such behavior was not observed for the other three test series. Moreover, the change in weight was very low at some of these conditions to record what you would assume would occur for a normal device that did not produce weight changes.

At this point, there was some disappointment about results, and obviously the imprinting had made the device operate in a more nonlinear fashion than in the past. Moreover, the earlier results could not be repeated since this device now acted as a totally different system. Runs were made at higher voltages as high as 325 volts with no notable consequences worth reporting.

A reference trial was performed where there was no voltage at the rollers and the carousel moved first in one direction and decelerated to a stationary state. The device was restarted in the opposite direction and was eventually decreased to cease operations. Results were totally unexpected as follows.

The initial weight includes the device, cabinet, and supporting equipment. The weight shown in figure 13 first dropped from 447 pounds to 433 pounds, and held constant with resonance spikes at 220 and 400 rpm. A weight spike at about 2180 seconds dropped to 425 pounds. The weight returned to the initial weight and then, at a different direction, dropped a minimum of 431 pounds. A maximum weight loss occurred at 22 pounds at about 12%, and an average loss in direction was 14 pounds at 7.3%. The initial objective of this run was designed to establish resonances but the results changed weight right away. Moreover, one may argue that less weight may occur at one direction over the other but this would have been reasonable only if the rotation rate history was identical. Unfortunately for this run, the different direction went to a higher rotation rate, and results at different directions were apples versus oranges.

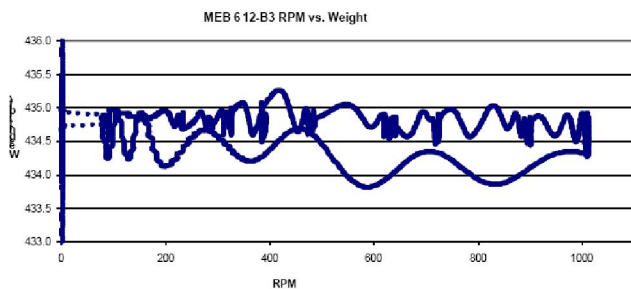

Figure 12 : Behavior demonstrated a typical response with less resonance effects and the sinusoidal signal when electric power was removed. The rollers were charged at 325 volts.

Compared to the other test series, there was no behavior where the weight changed for a considerable time of period and higher result magnitudes occurred only at transient situations. The weight loss of 7.3% would easily be assumed as greater than experimental error at .1 or .2 pounds.

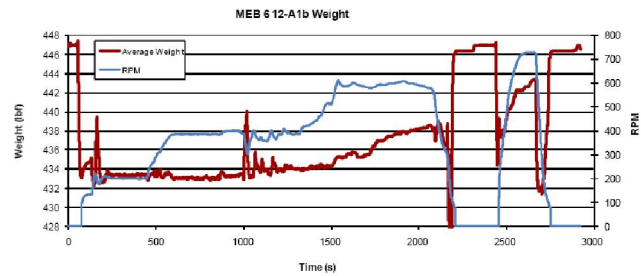

Figure 13 : This unusual weight history resulted with no roller electrical charge at both directions.

The success of these runs encourages us to pursue and complete the manufacture of a tapered ring system. After these different tests and results, a variant device would explore these ideas for further changes in weight reduction situations. The increase in the angle of the ring is designed to extend the electric and magnetic fields of the rollers that should alter weight. In other words, using the current configuration, the charge on the roller is limited by the spacing between the roller and the ring. By using this geometry, spacers could be used to extend the carousel and increase the spacing between the rollers and the ring thereby allowing for larger voltages of the order of 1,500 volts.

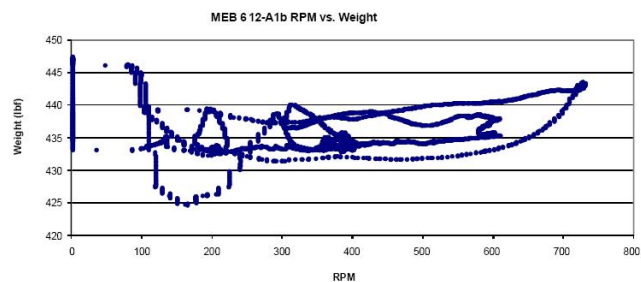

Figure 14 : The unusual behavior demonstrated events as a function of acceleration versus deceleration. Resonance was not as expected at 200 and 400 rpms. The lowest value occurred when the first portion of the run was decelerated or stopped running at about 2180 seconds.

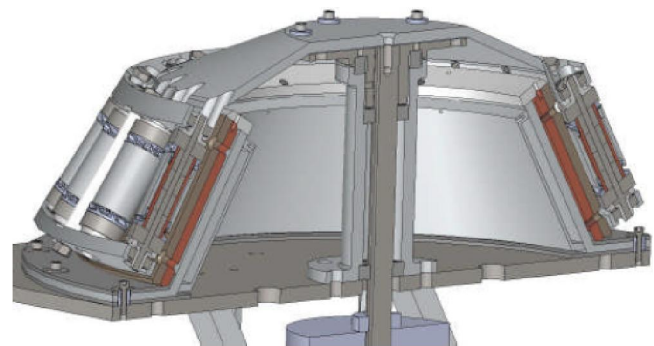

Figure 15 : The tapered ring device- a future reality that could use more weight.

## CONCLUSIONS

Basically from these results, the energy box validated some of the interesting phenomena discussed by the russians.



This includes weight increases, decreases, magnetic walls, and presence of ozone. Weight measurement spikes of the energy box indicate a higher weight loss fraction than the 35% suggested by the russians during transient motion.

There are at least three interesting alternative theories for this nonlinear machine. This includes several options theorizing about converting angular rotation to linear momentum, a poynting field force effect, or using retarded potentials where the ring acts like a reflection ground plane against the electric and magnetic fields of the roller's images. Clearly this energy box is a nonlinear mechanism by virtue of the unusual magnetic and electrical fields. All of these notions require further clarification with additional tests as well as the possibility of inducing gravitational fields. Rollers could represent electromagnetic dipoles that repulse gravitational fields, which are also among other possibilities. Additional variants of the energy box are currently being fabricated.

## REFERENCES

- [1] J.Thomas; Antigravity: The dream made reality, The Story of John Searl (1993).
- [2] P.A.Laviolette; "How the searl effect works: Analysis of the magnetic energy converter", June 17 (2001).
- [3] S.Gunnar Sandberg; "The searl-effect generator-design and manufacturing procedure", School of engineering and Applied Sciences, University of Sussex, Seg-003 and Seg-004, March (1986).
- [4] Paul Brown's notebook on Searl's device.
- [5] S.M.Godin, V.V.Roschin; In the USSR. "Orbiting multi-rotor homopolar system", a US patent 6.822,361 for this device held by energy and propulsion systems, Valencia Ca, Nov. (2004).
- [6] V.V.Roschin, S.M.Godin; An experimental investigation of the physical effects in a dynamic magnetic system., AIAA Paper, 2001-3660 (2001).
- [7] V.V.Roschin, S.M.Godin; An experimental investigation of the physical effects in a dynamic magnetic system., Technical Letters, 26(12), 1105-1107 (2000).
- [8] A.R.Karimov, L.Stenflo, M.Y.Yu; Coupled flows and oscillations in asymmetric rotating plasmas., Physics of Plasmas, 16, 102303 (2009).
- [9] A.R.Karimov, L.Stenflo, M.Y.Yu; Coupled azimuthal and radial flows and oscillations in a rotating plasma., Physics of Plasmas, Published online, 16, 062313, June 29 (2009).
- [10] A.R.Karimov, S.M.Godin; Coupled radial.azimuthal oscillations in twirling cylindrical plasmas., IOP Publishing Physica.Scripta., Phys.Scr., 80, 035503 (6pp), Published 25 August (2009).
- [11] J.E.Brandenburg; "A theoretical value for the newton gravitation constant from the gem theory of field unification and the kursunoglu-brandenburg hypothesis of massive gamma-ray bursters", The launching of La Belle Époque of high energy physics and cosmology, 112-119 (2003).
- [12] P.A.Murad, J.E.Brandenburg; "The murad-brandenburg equation-a wave partial differential expression for the poynting vector/ field conservation", AIAA 50<sup>th</sup> Aerospace Science Meeting, AIAA paper, 2012-0997, Nashville, Tennessee, Jan 9-12, (2012).
- [13] H.A.Lorentz, H.Weyl, H.Minkowski; "Einstein: The principle of relativity", Dover publications, inc., (1952).
- [14] Private conversations with Devon Tassen.
- [15] Private conversations with Ivan Kruglak at a technical meeting.