

2014

# BioTechnology

*An Indian Journal*

FULL PAPER

BTAIJ, 10(12), 2014 [6312-6318]

## Speed control strategy for a four wheel drive and four wheel steering vehicle with two electromotors

Lei Dong<sup>1\*</sup>, Bukang Wang<sup>2</sup><sup>1</sup>School of Mechanical and Power Engineering, North University of China, Taiyuan, Shanxi, 030051, (CHINA)<sup>2</sup>Taiyuan Research Institute, China Coal Technology & Engineering Group Corp, Taiyuan, Shanxi, 030006, (CHINA)

E-mail : dl060@163.com

### ABSTRACT

This study explores a new configuration of 4WD-4WS (four-wheel drive and four-wheel steering) underground vehicle. The vehicle was driven by two electromotors to enhance the motility and turned by several spatial links to reduce the turning radius with this configuration. Exploiting the new electric vehicle attaches considerable importance to the choice of the control strategy of the driving system. A dynamics mathematical model was established firstly and the instantaneous responses of the electromotors power were obtained by numerically solving the equations. Simulation results elucidate that the inner electromotor rotation speed fallen control strategy had the merit of the smooth vehicle speed and power outputs. This control strategy minimized the disadvantages of overburden of the electromotor. Additionally, field tests were carried out to evaluate the dynamics model and proved that the model was quite accurate.

### KEYWORDS

4WD-4WS underground electric vehicle; Control strategy; Real vehicle field test.



## INTRODUCTION

This work reports a novel shape of 4WD-4WS underground vehicle to carry the coal. The 4WS technique has been developed over the past decade because of its advantages such as the least turning radius and so on<sup>[1,2]</sup>. A great number of studies have been made on how to realize the 4WS technique since the first 4WS system was reported<sup>[3,4]</sup>. So far, the solutions mentioned for the 4WS technique are mainly based on electrical controller in the field of the engineering vehicles. However, few underground vehicles are equipped with it because of the low security and tough working conditions. Therefore, to find a kind of structure that could achieve the goal of the 4WS is necessary and exigent for the underground vehicle, which drives in the narrow laneway. The turning mechanism of the vehicle discussed in this article is composed of several links and spherical joints. The links moved spatially carry out the 4WS technique without any electrical elements.

The driving system is one of the most important components of the vehicle chassis. Many researchers had investigated the 4WD vehicle by using computer simulation and real vehicle testing. In previous papers<sup>[5,6]</sup>, a theoretical model of the 4WD technique was developed to predict the performance of the driving system. The studies to evaluate the control strategy of the 4WD vehicle were also developed in several published papers<sup>[7-9]</sup>. Similarly to the 4WS, most electric vehicles (EV) equipped four electromotors in the tires hub. This underground vehicle has two electromotors driving the left two tires and right two tires separately on account of the limitation of the coal transportation mechanism. There has not been a paper or technical publication dealing with the 4WD vehicle driven by two electromotors in that the driving system is unique thus far.

Therefore, it is important for in-depth estimation of this dynamics system to go into the performance study of it. This work deals with the modeling and control strategy of the motion of the vehicle on the horizontal plane. Although the model derived here is somewhat a crude approximation to the real motion, still, it gives an insight into the motion of the vehicle as a motion of a multi-body system. The remainder of this paper is organized as follows. Section 2 provides the driving system description of the vehicle. This includes a description of the vehicle turning mechanism. In Section 3, the focus is on the modeling of the 4WD-4WS vehicle. Section 4 deals with the control strategy and describes the computer simulation to predict the power response of the electromotors to the control strategy. Section 5 witnesses the result comparison between data obtained from a vehicle's field experiment and numerical data concluded from simulation model. The comparison demonstrated that the proposed mathematical model could accurately express the motion of the vehicle. Conclusions and further research reveal themselves in the final section. In brief, this paper concentrates on the engineering aspects of the research and evaluation of the experimental system.

## DRIVING AND STEERING STRUCTURE OF THE VEHICLE

The vehicle studied in this paper is used for carrying the coal underground. The vehicle can drive forward and backward at the same speed by rotation positively and negatively of the electromotor. There are two electromotors on the driving system positioned at the rear of the vehicle symmetrically as Figure 1 showed. The tires are stirred through the short and long transmission shafts. The tires at the same side were connected by the rigid shaft, so the rolling speed of these two tires is identical. In order to reduce the abrasion of the tires, the turning angles of the same side tires should be identical likewise. The turning mechanism is composed of several links and blocks as Figure 1. These components take the spatial motion by the spherical joints. The turning driven force is generated through two hydraulic cylinders controlled by hydraulic system. One turning block is swayed clockwise and the other anti-clockwise by the pull and push of the hydraulic cylinders. The synchronization of the movement is ensured by a synchronization axletree. With the motion of the synchronization blocks, two lengthways links are stirred spatially and bring direct arms to act. The direct arms are connected with the tires and also the indirect arms in the same side. There is only an indirect arm in the other side which is moved via a transverse link. Consequently, because of the spatial movement of the turning mechanism, the tires

at the same side turn the opposite direction. Furthermore, when the vehicle is turning, the angles of the inner tire and the outer tire could guarantee the satisfaction of the Ackermann theory by the optimization of the turning mechanism.

### MODELING OF 4WD-4WS ELECTRIC VEHICLE

Firstly, the modeling of the 4WD-4WS vehicle was built for the further dynamics analysis. Because the speed of the vehicle is very low (8km/h at maximum), the air resistance force and lateral force are small and could be ignored. Therefore, as is shown in Figure 2, the dynamics equations of the vehicle could be expressed as

$$m \frac{d^2 s}{dt^2} = \sum_{i=1}^4 F_i - (P_{f1} + P_{f2}) \cos \alpha - (P_{f3} + P_{f4}) \cos \beta$$

$$I_z \frac{d^2 \theta}{dt^2} = (F_3 + F_4) b - (F_1 + F_2) a + P_{f1} (b \cos \alpha - c \sin \alpha) + P_{f2} (b \cos \alpha - d \sin \alpha) - P_{f3} (a \cos \beta + d \sin \beta) - P_{f4} (a \cos \beta + c \sin \beta)$$

where  $m$  is mass of the vehicle,  $F$  is the driven force of the each tire,  $P_{fi}$  is the rolling resistance force of the each tire,  $a$ ,  $b$ ,  $c$  and  $d$  are the distance from the center of mass and the tires,  $\alpha$ ,  $\beta$  are the turning angles of the inner tires and outer tires,  $I_z$  is the moment of inertia,  $s$  is the displacement and  $\theta$  is the angle displacement of the vehicle.

The turning mechanics are composed of spatial links shown in Figure 1. Thus the tires turning angles  $\alpha$  and  $\beta$  could be attained by the transmission function with the method of points transform matrix in another article.

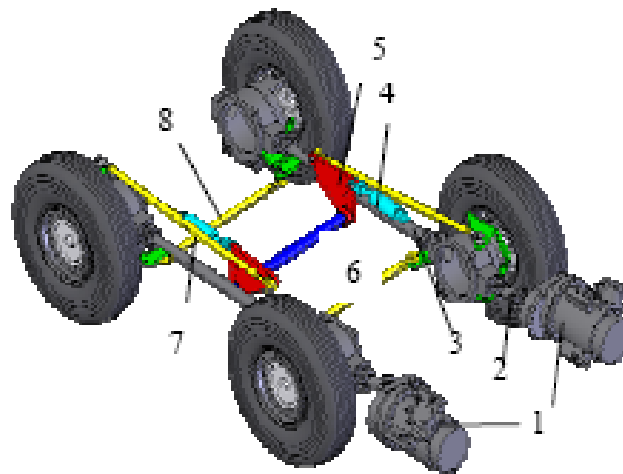

- 1-driving electromotor
- 2-short transmission shaft
- 3-long transmission shaft
- 4-turning hydraulic cylinder
- 5-turning block
- 6-synchronization axle
- 7-lengthways link
- 8-lengthways link

Figure 1 : The driving and turning system of the vehicle

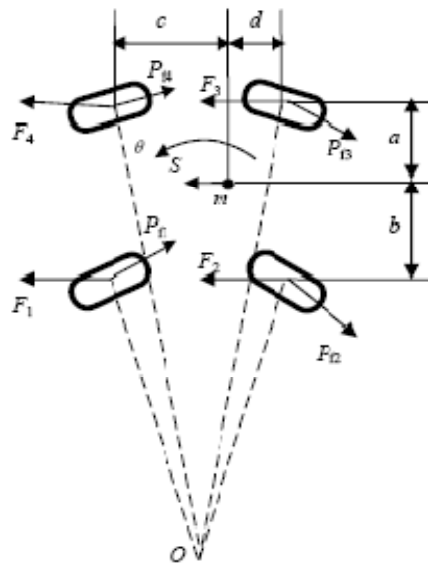

Figure 2 : The dynamics modeling of the vehic

**Electromotors modeling**

The output power of the electromotor could be expressed as

$$P = \frac{n \cdot F \cdot r}{9550 i \eta}$$

where  $n$  is the rotate speed of the electromotor,  $i$  is the transmission ratio from electromotor to tire,  $\eta$  is the efficiency from electromotor to tire,  $r$  is the actual radius of the tire.

**Driver modeling**

The driver modeling concentrated on how to connect the signals among the accelerate footplate, turning pole and the real movement of the vehicle. Define the speed of the vehicle as

$$\frac{ds}{dt} = \frac{v_{\max}(\varphi - \varphi_0)}{\varphi_{\max} - \varphi_0}$$

where  $v_{\max}$  is the maximum speed of the vehicle,  $\varphi_{\max}$  is the maximum displacement,  $\varphi$  is the driver input displacement and  $\varphi_0$  is the free displacement of the accelerate footplate.

In the same way, define the turning angle speed of the vehicle as

$$\frac{d\theta}{dt} = \frac{\omega_{\max}(\theta - \theta_0)}{\theta_{\max} - \theta_0}$$

where  $\omega_{\max}$  is the maximum speed of the vehicle,  $\theta_{\max}$  is the maximum angle displacement,  $\theta$  is the driver input angle displacement and  $\theta_0$  is the free angle displacement of the turning pole.

**Speed control system and dynamics analysis**

The simulation modeling was built in software MATLAB/Simulink, according to the dynamics math modeling talking above. There were two speed distribution modes in the speed control strategy. The first one was the rotate speed of outer electromotor was on steady and the inner one descended its rotate speed by multiplying a coefficient. The coefficient was the ratio between the turning radius of

inner tire and the outer tire. The second mode was the rotate speed of inner electromotor was invariable and the outer one ascended by dividing the coefficient.

The speed of the vehicle was an input of the dynamics system and the turning angle was the other one. The turning pole input took step signals which were defined as: the vehicle was driven straight from 0s to 2s at the speed of 1.19m/s that the electromotor be at rated rotate speed; the step signal was triggered at 2s and lasted 3 seconds; then the vehicle was at the steady speed and circle movement.

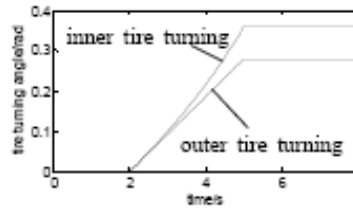

Figure 3 : The turning angle inputs of the system

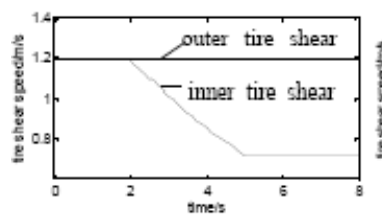

Figure 4 : The speed inputs of the first distribution mode

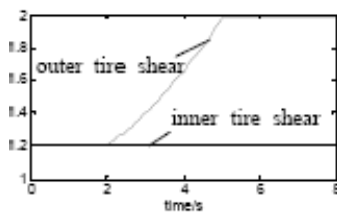

Figure 5 : The speed inputs of the second distribution mode

The turning angle input was applied on the two speed modes just as Figure 3 in the simulation. The speed inputs are Figure 4 and Figure 5 for the two distribution modes.

The results of the simulation were shown as Figure 6 and Figure 7. From these data we could draw:

(1) With the increase of the turning angle, namely decline of the turning radius, the power of the outer electromotor ascends and the inner electromotor descends.

(2) At the beginning of the turning, the power of the both electromotors fall a little in the first speed distribution mode. The reason is that the speed of center of vehicle mass is declining when the driver is running the turning pole. Therefore, the acceleration value is negative. In the second mode, the condition is reversed.

(3) The curves in the Figure 6 are sharper than the ones in the Figure 5. Before the steady circular movement of the vehicle, otherwise, the power of the outer electromotor has already exceeded the final value. The maximum datum is 16.3% larger than the steady value. This could lead to go beyond the rated power of the electromotor and make hurt to it. Therefore, the vehicle chose the first speed distribution mode as its control strategy.

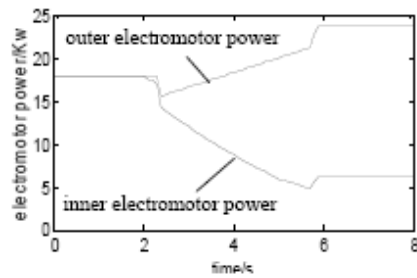

Figure 6 : The output power of the electromotor in the first mode

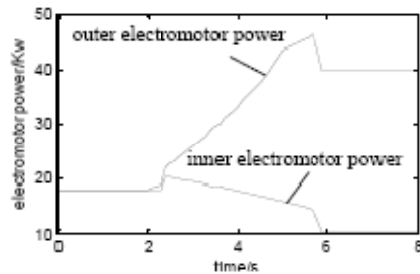

Figure 7 : The output power of the electromotor in the second mode

### REAL VEHICLE TESTING

In order to validate the math modeling and the control strategy, the test of real vehicle on cement road was carried out. Due to the restriction of the testing instrument, the power of the electromotor also could be acquired by the next formula:

$$P = \sqrt{3}UI \cos \varphi$$

where  $U$  is the effectual voltage value,  $I$  is the effectual electric current,  $\cos \varphi$  is the power factor of the electromotor, which could be confirmed through the electromotor manufacture company. The sensors disposition of the real vehicle testing is as Figure 8 and the result curves are on Figure 9.

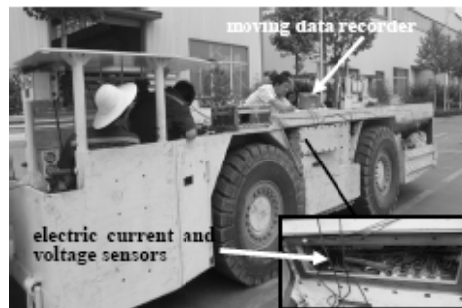

Figure 8 : The sensors disposition on the electrical control box of the vehicle

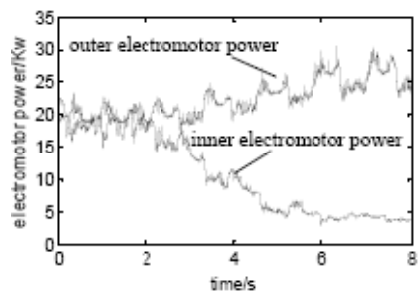

Figure 9 : The testing power of the electromotors

Thus the maximum comparative error between the simulation and the testing value is 14% which could be calculated from the Figure 9. The math modeling could describe the movement of the real vehicle to a rather precision extent consequently.

## CONCLUSIONS

A mathematical model for the 4WD-4WS vehicle driven by two electromotors has been developed in terms of the characteristics of turning on plane. Electromotors response to the vehicle speed and tire turning angles has been studied by computer simulation to evaluate the control strategy of the vehicle. As a result, this model has been applied to the study of the low speed and heavy duty underground vehicle. The tire slip force should be considered in the future study, which was ignored in this paper in that the speed of the underground vehicle was very low. Comparing the theoretical and the experimental responses of the system, it may be concluded that the model fairly represents the behavior of the system under the error is less than 14%, and therefore, it may be useful in developing analytical methods for the 4WD-4WS electric vehicle.

## ACKNOWLEDGMENT

This work was financially supported by Shanxi Province Science Foundation for Youths (2014021024-4). We also thank the editor and anonymous referees for their valuable comments.

## REFERENCES

- [1] K.Watanabe, J.Yamakawa, M.Tanaka et al.; Turning characteristics of multi-axle vehicles. *Journal of Terramechanics*, **44**, 81-87 (2007).
- [2] H.Itoh, A.Oida, M.Yamazaki; Measurement of forces acting on 4WD-4WS tractor tires during steady-state circular turning in a rice field, *Journal of Terramechanics*, **32(5)**, 263-283 (1995).
- [3] Namio Irie, Junsuke Kuroki; 4WS technology and the prospects for Improvement of vehicle dynamics, SAE Paper901167, (1990).
- [4] Nagai Masao, Hirano Yutaka et al; Integrated control of active rear wheel steering and direct yaw moment control, *Vehicle System Dynamics*, **27(5-6)**, 357-370 (1997).
- [5] Y.Yavin; Modeling the Motion of a Cart with Steerable Wheels, *Mathematical and Computer Modeling*, **37**, 1253-1258 (2003).
- [6] Y.Yavin; Modeling the Motion of a Car with Four Steerable Wheels, *Mathematical and Computer Modeling*, **38**, 1029-1036 (2003).
- [7] J.Wang, Q.Wang, L.Jin et al; Independent wheel torque control of 4WD electric vehicle for differential drive assisted steering, *Mechatronics*, **21**, 63-76 (2011).
- [8] Junya Yamakawa, Akira Kojima, Keiji Watanabe; A method of torque control for independent wheel drive vehicles on rough terrain, *Journal of Terramechanics*, **44**, 371-381 (2007).
- [9] Sun Hui, Jiang Ji-hai, Wang Xin; Torque control strategy for a parallel hydraulic hybrid vehicle, *Journal of Terramechanics*, **46**, 259-265 (2009).