

Sensitivity analysis and determination of optimum temperature of furnace for commercial visbreaking unit

S.Reza Seif Mohaddecy*, Sepehr Sadighi

Catalytic Reaction Engineering Department, Catalysis and nanotechnology Division,
Research Institute of Petroleum Industry (IRAN)

E-mail : seifsr@ripi.ir; sadighis@ripi.ir

ABSTRACT

In this study the visbreaking unit of Tehran refinery was simulated and then a parametric sensitivity analysis was carried out for determination of optimum temperature. The Petro-Sim simulator, which specializes in the simulation of refinery processes, was used in this study. Initially the simulator was validated using actual plant test runs and after tuning, the simulations provided errors less than 3%. Using the validated simulator the sensitivity of yield of fuel oil, gasoline and fuel oil viscosity with the variation of furnace temperature (reaction temperature) was investigated. The validated simulator was used to optimize the unit operating conditions to obtain the desired product specifications. The optimum value of fuel oil yield, gasoline yield, viscosity and temperature were 91.51, 6.18, 79.6 cSt and 824 °F, respectively. © 2013 Trade Science Inc. - INDIA

KEYWORDS

Visbreaking;
Fuel oil;
Simulation;
Petro-Sim;
Sensitivity analysis.

INTRODUCTION

Visbreaking appears like an alternative for the conversion or transportation of heavy crudes. It is a relatively mild thermal cracking process mainly used to reduce vacuum tower bottoms viscosities and pour points and to reduce the amount of cutting stock required for residue dilution to meet fuel oil specifications^[1-3]. Heavy fuel oil production can be reduced from 20 to 35 % and cutter stock for dilution by 20 to 30 % by visbreaking. This increases the yield of more valuable distillates directly converted from visbreaking or used as catalytic cracker feedstocks. In a refinery, this one process allows to the production of fuel oil and feed for the catalytic cracking units^[4,5].

The aim of this research is developing a simple yield predictor model, according to a process simulation; to

predict the most added value products consists of gas, LPG, gasoline, diesel and visbroken fuel oil in a commercial soaker unit. The main advantage of this work is investigation of influence of operation conditions on the products yield such as fuel oil and gasoline.

As mentioned, Soaker visbreaking unit of Tehran refinery has simulated and the operating variables effects on the yield and quality of products have studied.

PROCESS DESCRIPTION

The vacuum residuum, which is stored in two tanks at 93 °C, is charged to the unit. It picks up heat from the partly cooled product in the cold charge heat exchanger, and accumulates in charge surge drum.

The charge from surge drum splits and goes through two parallel coils of the heater. The flow through each

coil is on flow control. In the hip section of each coil is a steam injection point. The visbreaking furnace is constructed from two sections which are fired independently.

After the coil furnace, the two hot streams coverage in a transfer line; then the mixed product is entered into the soaker drum. A quench stream of cooled product is added on flow control; the combined stream en-

ters the flash section of flash fractionator. In the flash section, operating at 80 psig pressure, much of the gas, gasoline and distillate formed during the cracking process flash off.

For split some light gas content in the fuel oil and gasoline products, two stripper and stabilizer columns are used. The simplified process flow diagram of the described unit is shown in Figure 1.

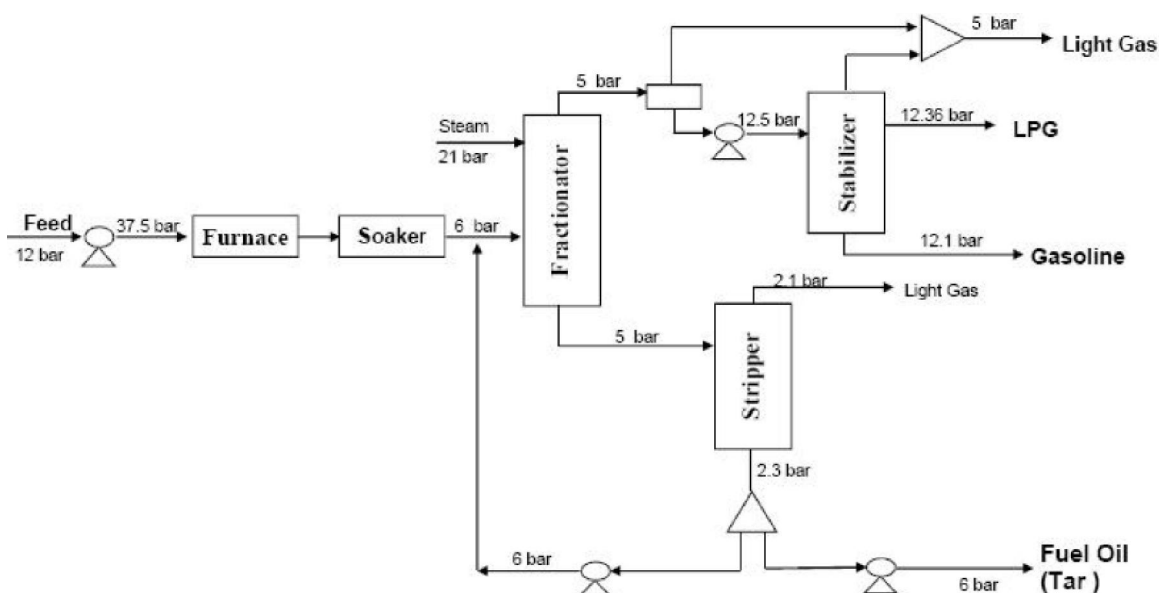

Figure 1 : Block flow diagram of visbreaking process

The specifications of coil and the soaker drum of Tehran refinery are presented in TABLES 1 and 2. The output product from the soaker drum is quenched by the cooled product to stop the more cracking reactions after the soaker to inhibit the coke formation. The combined stream is transferred to the fractionation tower and side strippers to separate the visbreaking products.

TABLE 1 : Specifications of the coil of the visbreaking unit

Variable	unit	value
Number of tubes	-	128
Number of convection tubes	-	76
Number of radiation tube	-	52
Tube length	m	18.745
Outside diameter	m	0.114

TABLE 2 : Specifications of the soaker of the visbreaking unit

Variable	unit	value
Outside diameter	m	2.405
Length	m	16.5

PROCESS SIMULATION AND VALIDATION

Petro-Sim, developed by KBC company, is a simulator which is capable to simulate an industrial scale of catalytic and non-catalytic^[6]. This simulator can simulate the visbraking unit with soaker or without soaker drum. In this paper, Petro-Sim has been used to simulation and sensitivity analysis of visbreaking unit of Tehran refinery.

Tehran refinery soaker-visbreaker unit was simulated as a case study (Figure 2). This unit was designed to visbreak 20,000 barrel per day of a mixture of Vacuum Residuum and Slop Vacuum Gas Oil which are both taken from the vacuum tower; the composition of the fresh feed can vary slightly with time from start of run (SOR) to end of run (EOR).

Data gathering of unit from feed and products as test run are needed for visbreaking unit simulation, during of data gathering, a few set of data comprising of product flow rates, feed inlet temperature and soaker

Full Paper

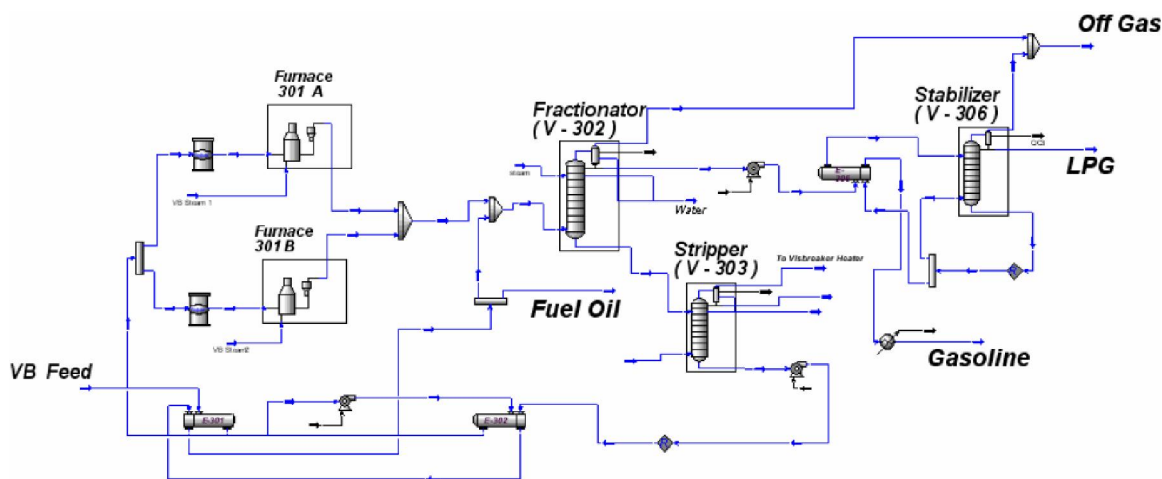

Figure 2 : Simulation of visbreaking unit at Tehran refinery

outlet temperature were gathered from the commercial visbreaking unit in Tehran which data gathered are shown in TABLES 3 to 8.

TABLE 3 : Specifications of the feed

Variable	Unit	Value
Feed rate	kg/hr	132500
Feed density	kg/m ³	1006
Feed temperature	°C	93
Feed pressure	bar	11.89

Distillation Analysis (ASTM D1160)

IBP	°C	203
5 % vol	°C	409
10 % vol	°C	457
20 % vol	°C	503
30 % vol	°C	543
50 % vol	°C	585
Nitrogen content	% Wt	0.4
Sulfur content	% Wt	3.19
Asphaltic content	% Wt	5.1
Kinematic viscosity (100 °C)	cSt	430
Nickel content	ppm	53
Vanadium content	ppm	135

TABLE 4 : Specifications of furnace

Variable	Unit	Value
Inlet temperature	°C	345.8
Outlet temperature	°C	440.5
Inlet pressure	Bar	7
Outlet pressure	Bar	31
Number of tubes	-	128
Number of tubes (Convection zone)	-	76
Number of tubes (Radiation zone)	-	52

TABLE 5 : Specifications of the injected steam

Variable	Unit	Value
Rate	kg/hr	150
Temperature	°C	316
Pressure	bar	44.82

TABLE 6 : Specifications of gas producing

Variable	Unit	Value
Flow Rate	Barrel/day	901
Density	-	0.001

Composition

Methane	Vol %	36.9
Ethane	Vol %	24.38
Propane	Vol %	20.56
Isobutene	Vol %	4.94
n-butane	Vol %	5.03
Isopentane	Vol %	0.77
n-pentane	Vol %	0.52
Hydrogen sulfide	Vol %	6.91

TABLE 7 : Specifications of gasoline producing

Variable	Unit	Value
Flow rate	Barrel/day	1222
Density	-	0.744
Sulfur	Wt %	3.4

Distillation Analysis (ASTM D86)

IBP	°C	48
5 % vol	°C	67
10 % vol	°C	76
30 % vol	°C	110
50 % vol	°C	141
70 % vol	°C	163
90 % vol	°C	184
95 % vol	°C	190
FBP	°C	201

TABLE 8 : Specifications of fuel oil producing

Variable	Unit	Value
Flow Rate	Barrel/day	18180
Density	-	.9995
Distillation Analysis (ASTM D1160)		
IBP	°C	452
5 % vol	°C	502
10 % vol	°C	528
20 % vol	°C	559
30 % vol	°C	584
Sulfur content	% wt	3.4
Asphaltic content	% wt	8.3
Kinematic viscosity (100 °C)	cSt	80
Nickel content	% Wt	0.004
Vanadium content	% Wt	0.0153

As it is illustrated in Figure 2, off gases including C1, C2 and LPG, gasoline and tar are the output streams from the visbreaking plant. It is possible to take the gas oil product from the stripper tower, but it is usually blocked to mix up the gas oil as a cutter blend with the fuel oil.

For evaluating of simulation of visbreaking unit, Comparison of the operating data of Tehran refinery and typical simulation results were shown in TABLES 9 and 10. From them, the ability of simulation to predict the desired outputs was confirmed.

TABLE 9 : Comparison of gas product between actual data and simulation results

Variable	unit	Simulation	Actual
Rate	Barrel/day	887.8	901
Hydrogen sulfide	Vol %	6.57	6.91

TABLE 10: Comparison of gasoline product between actual data and simulation results

Variable	unit	Simulation	Actual
Rate	Barrel/day	1230	1222
Hydrogen sulfide	Vol %	3.322	3.4

TABLE 11 : Comparison of fuel oil product between actual data and simulation results

Variable	unit	Simulation	Actual
Rate	Barrel/day	18190	18180
Hydrogen sulfide	Vol %	3.1	3.4
Kinetic viscosity (100 °C)	cSt	80.23	79

RESULTS AND DISCUSSION

Influence of the furnace outlet temperature increasing on products rate

Figure 3 shows the flow rate of fuel oil (desired product) in the visbreaking process as a function of temperature. As observed in Figure 3, the flow rate of fuel oil decreased about 1.5% with respect to increasing temperature. This decreased flow rate explained in conversion of fuel oil to gasoline in higher temperature via thermal cracking. Figure 4 shows the flow rate of gasoline (unwanted product) in the visbreaking process as a function of temperature.

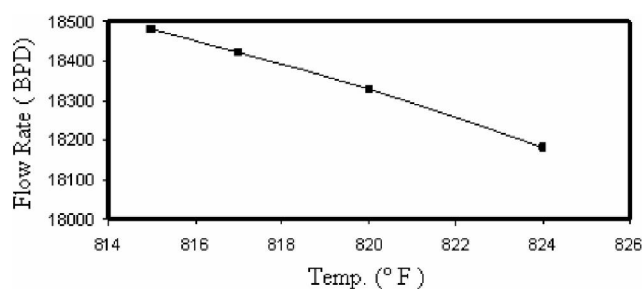

Figure 3 : Sensitivity of produced fuel oil versus the furnace outlet temperature

As shown in Figure 4, the flow rate of gasoline increased about 19% with respect to increasing temperature. It is the supporting evidence for higher conversion of fuel oil to gasoline in higher temperature due to thermal cracking.

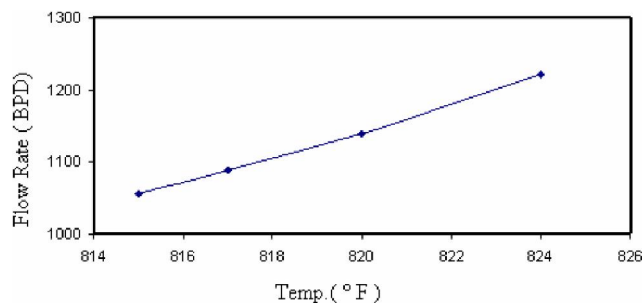

Figure 4 : Sensitivity of produced gasoline versus the furnace outlet temperature

Influence of the furnace outlet temperature increasing on produced fuel oil viscosity

Figure 5 shows the viscosity of fuel oil in the visbreaking process as a function of temperature. As observed in Figure 5, Viscosity decreases with increasing temperature as a non-linear curve. As expected, it is as power law.

Full Paper

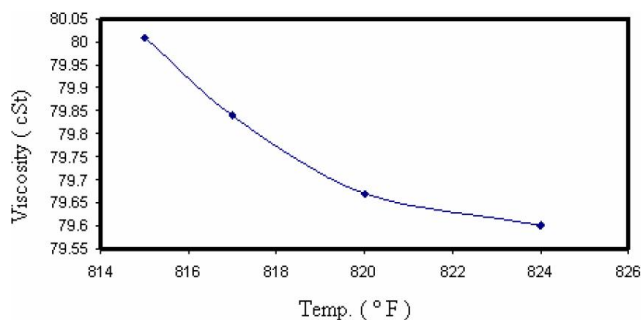

Figure 5 : Sensitivity of fuel oil viscosity versus the furnace outlet temperature

TABLE 12 : Comparison of fuel oil and gasoline yield versus furnace outlet temperature

Variable	Furnace Outlet Temperature (° F)								
	800	805	810	813	815	819	824	830	850
Fuel Oil Yield (Vol %)	94.86	94.23	93.58	93.19	92.93	92.29	91.51	90.44	86.37
Gasoline Yield (Vol %)	4.34	4.68	5.03	5.25	5.39	5.74	6.18	6.79	9.16

TABLE 13 : Selectivity of fuel oil to gasoline versus furnace outlet temperature

Variable	Furnace Outlet Temperature(° F)								
	800	805	810	813	815	819	824	830	850
Selectivity of fuel oil to gasoline	94.86	94.23	93.58	93.19	92.93	92.29	91.51	90.44	86.37

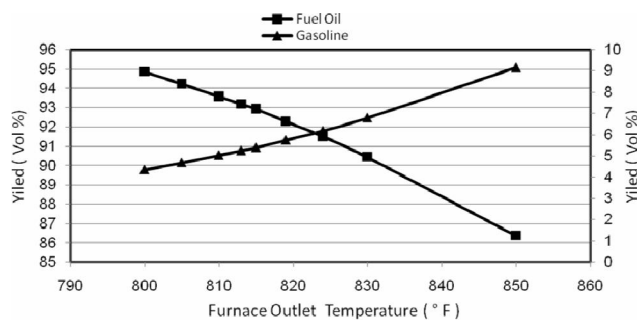

Figure 6 : Comparison of fuel oil and gasoline yield versus furnace outlet temperature

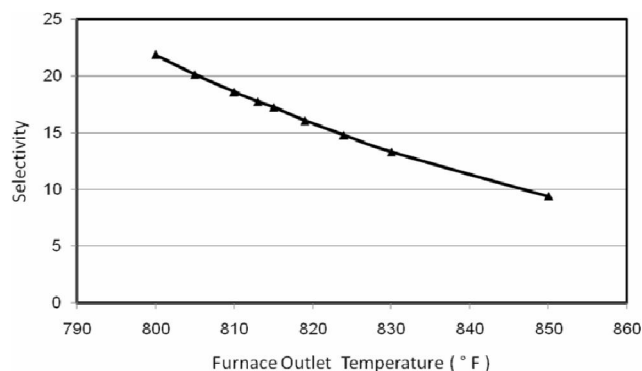

Figure7 : Selectivity of fuel oil to gasoline versus furnace outlet temperature

fuel oil to gasoline ratio in suitable fuel oil viscosity. The optimum values of fuel oil and gasoline yield, viscosity and temperature are 91.51, 6.18, 79.6 Cst and 824 °F, respectively.

Optimum furnace temperature

In commercial visbreaking process, determination of suitable temperature of furnace in order to maximum yield of fuel oil, minimum yield of gasoline and minimum value of fuel oil viscosity is very important. For comparison the products yield of visbreaking process, yield of fuel oil and gasoline is shown in TABLE 12 and Figure 6 as a function of temperature.

As shown in Figure 6, there is a optimum temperature for furnace. In this temperature, there is maximum

Figure 7 and TABLE 13 shows the Selectivity of fuel oil to gasoline in the visbreaking process as a function of temperature. As observed in Figure 7, viscosity decreases with increasing temperature. The optimum selectivity is 15.6 in 824 °F.

CONCLUSION

In this paper, Tehran refinery visbreaking operating data has gathered for using to calibration of simulator, and then this unit has simulated in Petro-Sim environment. After confirmation of simulator and results of simulation, the effect of increasing the furnace outlet temperature on fuel oil and gasoline rate and also fuel oil viscosity has investigated.

Sensitivity analysis for viscosity and products rate has shown that increasing the furnace temperature causes increasing the gasoline rate and decreasing the fuel oil rate and viscosity. This results and other constrains such as products quality and furnace temperature were used for unit optimization.

Furnace Optimum Temperature is very important for predicting the furnace performance in visbreaking process in order to produce fuel oil with a suitable viscosity for using in transportation of heavy crudes and other refinery processes.

After comparison of products yield, selectivity and viscosity versus furnace temperature, The optimum value of fuel oil and gasoline yield, viscosity and temperature are 91.51, 6.18, 79.6 cSt and 824 °F, respectively.

REFERENCES

- [1] A.M.Benito, M.T.Martínez, I.Fernández, J.L.Miranda; Visbreaking of an asphaltenic coal residue. *Fuel.*, **74(6)**, 922-927 (1995).
- [2] K.L.Kataria, R.P.Kulkarni, A.B.Pandit, P.B.Joshi, M.M.Kumar; Kinetic Studies of Low Severity Visbreaking. *Ind.Eng.Chem.Res.*, **43(6)**, 1373–1387 (2004).
- [3] I.A.Wiehe; Process Chemistry of Petroleum Macromolecules. CRC Press., (2008).
- [4] J.B.Joshi, A.B.Pandit, K.L.Kataria, R.P.Kulkarni, A.N.Sawarkar, D.Tandon, Y.Ram, M.M.Kumar; Petroleum Residue Upgrading via Visbreaking: A Review. *Ind.Eng.Chem.Res.*, **47(23)**, 8960–8988 (2008).
- [5] Upgrading Process of Heavy Oil JCCP Technical Training Course, June (2005).
- [6] Petro-Sim User Guide, KBC Advanced Technologies, KBC Profimatic., (2012).