



Trade Science Inc.

Research & Reviews In

Electrochemistry

Full Paper

RREC, 2(2), 2010 [88-94]

Electrocatalytic oxidation of acetaminophen on a nickel oxyhydroxide-modified electrode

M. Dehghani Mobarake

Energy Research Center, Renewable Energy Department, Research Institute of Petroleum Industry (RIPI),
P.O. Box 14665-1998, Tehran, (IRAN)

E-mail : dehghanim@ripi.ir

Received: 16th October, 2010; Accepted: 26th October, 2010

ABSTRACT

In the work presented here, Nickel electrode by NiOOH was prepared by galvanostatic deposition. This electrode was used for electrocatalytic activities towards the oxidation of acetaminophen in alkaline solutions. Various techniques such as cyclic voltammetry (CV), chronoamperometry (CA) and impedance spectroscopy (EIS) were utilized to study the samples. The cyclic voltammogram of Ni proved the formation of α/β crystallographic forms of the nickel oxyhydroxide under prolonged repetitive potential cycling in alkaline solution. In CV studies Ni/NiOOH modified electrode showed a significantly response to the acetaminophen oxidation. This work clearly revealed that this electrode is an effective electrocatalyst for detection of acetaminophen. © 2010 Trade Science Inc. - INDIA

KEYWORDS

Ni/NiOOH electrodes;
Electrocatalysis;
Acetaminophen;
Paracetamol;
Acetaminophen detection;
Catalytic reactions.

INTRODUCTION

Acetaminophen was introduced into western medicine over 100 years ago^[1-3]. It, as a safe and effective analgesic and antipyretic, has been available on the worldwide market for a long time.^[1]

Craig E. Banks et al. studied the electrochemical oxidation of N(4-hydroxyphenyl)ethanamide (Paracetamol or Acetaminophen) at C₆₀-modified glassy carbon electrodes. This work clearly showed that substrate activation is an important parameter for study of C₆₀-film-modified electrodes, especial in electro-analysis application.^[2]

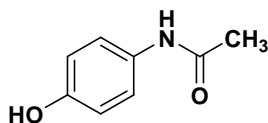

Ni modified or Ni alloy electrodes have commonly been used as an electrocatalyst for both anodic and cathodic reactions in organic synthesis and water electrolysis, direct alcohol electro oxidation^[4-11]. One of the most important application of nickel is using as a catalyst in oxidation of alcohols. Several studies of the electro-oxidation of alcohols on Ni have been reported before, also^[10,12].

Except to Ni, Nickel hydroxides and complex modified Ni-electrodes have been used for a variety of electro oxidation^[13-20] and reduction purposes.^[21]

But here, we have studied the electrochemical oxidation of acetaminophen on a nickel electrode in NaOH solution by derivation of the kinetic parameters of electro catalytic process.

METHODS AND MATERIALS

Chemical used

Sodium hydroxide, and the nickel rod was received from Merck. Acetaminophen was obtained from Borhan Daro Company. All chemicals were analytical grade.

Characterization

Electrochemical studies were carried out in a conventional three electrode cell powered by an electrochemical system comprising of EG&G model 273 potentiostat/galvanostat and Solartron model 1255 frequency response analyzer. The system is run and controlled by a PC through M270 commercial software via a GPIB interface. A dual Ag/AgCl-Saturated KCl, a Pt wire and a graphite (G) disk electrode were used as the reference, counter, and working electrodes, respectively. All studies were carried out at 298 ± 2 K. The G disk electrode was polished with 0.05 mm alumina powder on a polishing micro cloth and rinsed thoroughly with doubly distilled water before modification.

Working electrode, Ni/NiOOH rod, was prepared by fifty cycles between 0 to 600 mV at a 100 mV/s scan rate in a 1M NaOH solution.

RESULTS AND DISCUSSION

Figure 1 shows the 50 consecutive cyclic

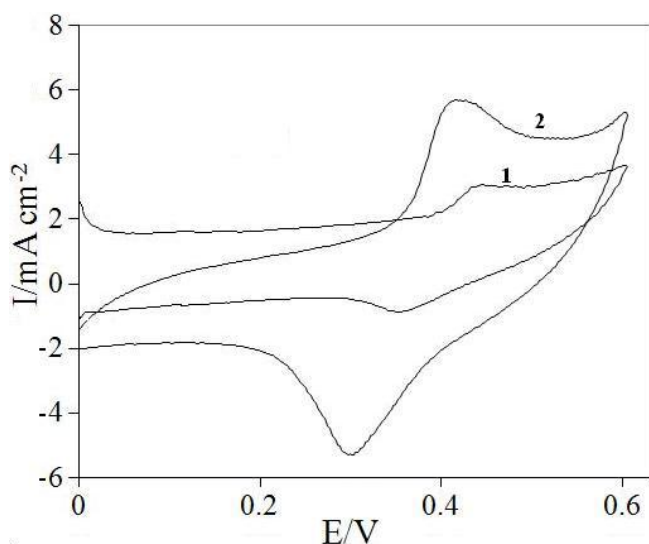

Figure 1 : Consecutive 50 cycles voltammogram of Ni/NiOOH electrode in 1M NaOH at a scan rate of 100 mVs⁻¹. (1) first cycle (2) fifty cycle

voltammograms of the Ni electrode with 100 mV/s scan rate in 1 mol/l NaOH. In the first scan a pair of redox peaks appears at 450 mV and 500 mV which is assigned to Ni²⁺/Ni³⁺ redox couple in alkaline media. The entire behavior is in agreement with the previous data in the literature concerned to formation and inter conversion of α - and β -phases of Ni(OH)₂, its transformation to NiOOH, and the enrichment of Ni³⁺ species on or beneath the surface^[18-22].

Upon further cycles, the peaks shift cathodically and stabilize at 430 mV and 480 mV, respectively. In the subsequent cycles, both the anodic and cathodic peaks shift negatively and then stabilize; higher energies (potential) required for nucleation of NiOOH in the first cycle. The enhanced base line current of the first cycle is related to oxidation of Ni to Ni(II).

The current increases with the number of potential scans indicating the progressive enrichment of the accessible electro active species Ni²⁺ and Ni³⁺ on or near the surface. The increased current in anodic wave is as a result of oxygen evolution reaction.

After prolonged cycling, the redox peak potentials are stabilized at 388 mV and 471 mV Ag/AgCl.

These Changes are probably is due to changing^[18] in crystallite structure of of the nickel hydroxide and the nickel oxyhydroxide films.

It has been reported^[19,20] that at the initial stages of electro-oxidation α -Ni(OH)₂ forms and is slowly converted to β -Ni(OH)₂ form.

It is believed that both of the above phases are non-stoichiometric^[21,22].

Figures 2a presented typical CVs of a Ni modified NiOOH electrode in 1M NaOH solution at various potential scan rates of 2–2000 mVs⁻¹. The peak's currents are proportional to scan rates in the range of 2–40 mVs⁻¹, Figures 2b, c showed to the electrochemical activity of the surface redox couple^[23]. By following equation^[23] and with respect to slope of I_p versus v and taking average of both cathodic and anodic results, Γ^* (surface coverage) was estimated around 6.2×10^{-8} .

$$I_p = \left(\frac{n^2 F^2}{4RT} \right) v \Delta \Gamma^* \quad (1)$$

Γ^* value corresponds to the formation of approximately 54 monolayers of Ni/NiOOH surface species.

In the higher potential scan rate, it has a v^{1/2} depen-

Full Paper

density; Figures 2d, e showed the dominance of the diffusion controlled processes.

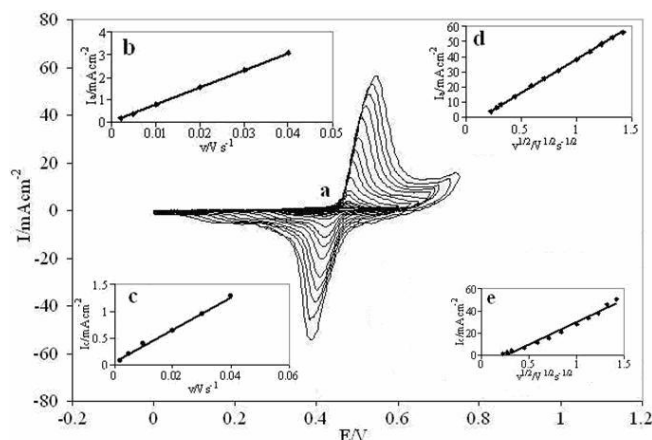

Figure 2 : (a) Typical cyclic voltammograms of a Ni/NiOOH electrode in 1 M NaOH in the potential sweep rates of 2, 5, 7, 10, 20, 30, 40, 50, 75, 100, 200, 350, 500, 750, 1000, 1250, 1500, 1750, 2000 mVs^{-1} , (b) the dependency of anodic and (c) cathodic peak currents to the sweep rate at lower values (2–40 mVs^{-1}). (d) The proportionality of anodic and (e) cathodic peak currents to the square roots of sweep rate at higher values (50–2000 mVs^{-1}).

Figure 3 presented the CVs of Ni/NiOOH electrode without (a) and in (b) of 3mM acetaminophen and (c) 9mM acetaminophen at the potential scan rate of 10mVs^{-1} . In study of electro oxidation of acetaminophen on Ni electrode it is^[24] revealed that the obtained current of anodic and cathodic were 35mAcm^{-2} in 3mM solution. The results showed anodic current rise against cathodic drop in presence of acetaminophen.

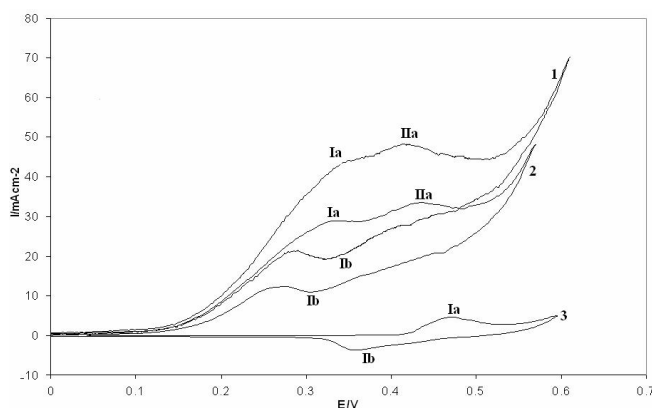

Figure 3 : Cyclic voltammograms in the presence of 5mM(a) and 1mM(b) of acetaminophen on Ni/NiOOH electrode and only Ni/NiOOH(c) in 1M NaOH solution. Potential sweep rate was 10mVs^{-1} .

Figure 4 showed the effect of acetaminophen concentration on the anodic and cathodic current of the

above electrode. It is clearly observed that the anodic current increases with acetaminophen concentration.

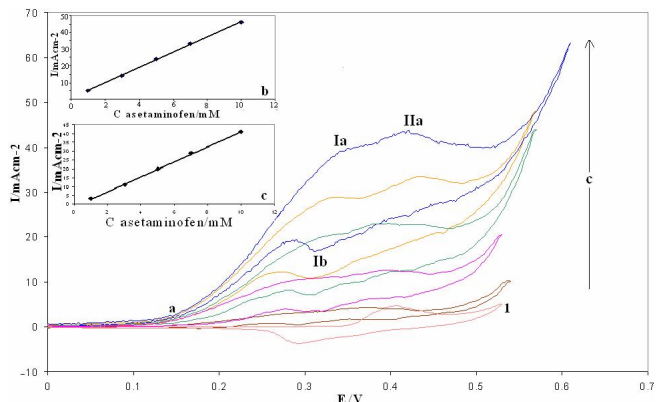

Figure 4 : (a) Cyclic voltammograms of the Ni/NiOOH electrode in 1M NaOH solution in the presence of (1) 1 mM; (2) 3 mM; (3) 5 mM; (4) 7 mM; (5) 9 mM of acetaminophen in the solution. Potential sweep rate was 10mVs^{-1} . (b) Dependency of the anodic peak current on the concentration of acetaminophen in solution. (c) Dependency of the cathodic peak current on the concentration of acetaminophen in solution

The enhancement of current ratio (anodic/cathodic) from 56/44 to 96/4 has been caused by acetaminophen component.

Figure 5 (a) depicted cyclic voltammograms of Ni/NiOOH in 5mM acetaminophen at different scan rates.

It showed that anodic/cathodic currents are proportional to the scan rates in a range of 2–2000 mVs^{-1} , as illustrated in Figure 5b and c respectively.

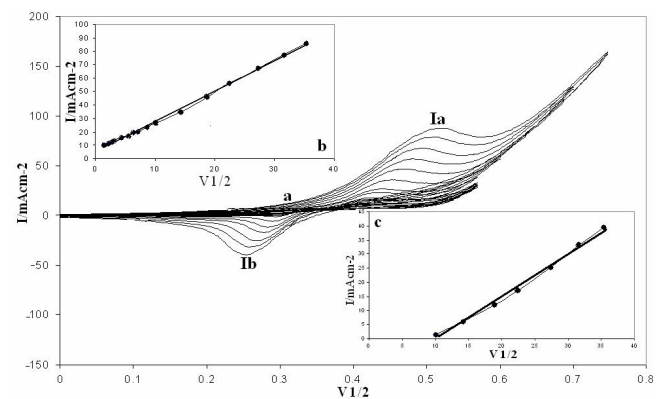

Figure 5 : (a) Typical cyclic voltammograms of the Ni/NiOOH in 1 M NaOH in the presence of 0.5 mM acetaminophen at various potential sweep rates of 2, 5, 7, 10, 20, 30, 40, 50, 75, 100, 200, 350, 500, 750, 1000, 1250 and 1500mVs^{-1} . (b) Dependency of anodic peak current during the forward sweep on the square roots of sweep rate. (c) The anodic current function ($I/v^{1/2}$) vs potential sweep rate v .

The cathodic peak was not observed at low scan rates, but appeared upon increasing the scan rate. This

phenomenon indicates that the electro oxidation of nickel species to higher valence state is much faster than the catalytic oxidation of ethylene glycol. At higher scan rates, a new oxidation peak was appeared for ethylene glycol oxidation at a potential much more positive than that of the oxidation potential of Ni(OH)₂.

A double steps chronoamperometry has been employed for the investigation of the processes via ErCi mechanism^[18]. The chronoamperograms of Ni/NiOOH electrode without (6) and presence of (1-5) acetaminophen in a concentration range of 1-9mM in 1M NaOH solution at the oxidation potential of 400 and 200mV as presented in Figure 6A. The plot of net current versus $t^{1/2}$ obtained by elimination of background current via point-by-point subtraction method. It gives a straight line those levels of around 0.27mA, (Figure 6B). A diffusion process controls the transient current. By using Cottrell equation^[25] and slop of I_p versus $t^{1/2}$, the diffusion coefficient of acetaminophen has been obtained around $5 \times 10^{-7} \text{ cm}^2 \text{ s}^{-1}$.

$$I = nFAD^{1/2}C^* \pi^{-1/2} t^{-1/2} \quad (2)$$

The irreversibility of acetaminophen oxidation process was proved by the obtained negligible current at 300 mV potential.

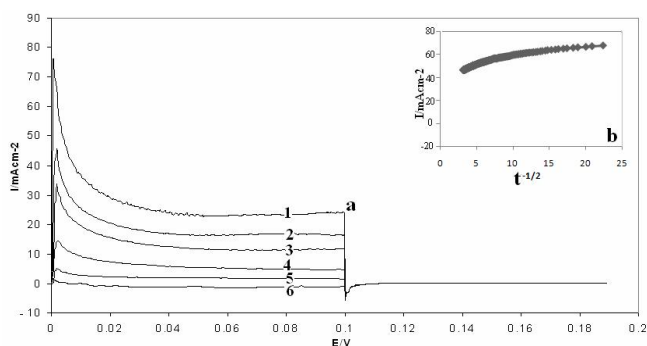

Figure 6 : (a) Double steps chronoamperograms of Ni/NiOOH electrode in 1 M NaOH solution with different concentrations of acetaminophen of: (1) 0 M, (2) 0.1 M, (3) 0.3 M, (4) 0.5 M, (5) 0.7M and (6) 0.9 M. Potential steps were 400 mV and 200 mV, respectively. (b) Dependency of transient current on $t^{1/2}$.

A number of mechanisms have been proposed for the electro oxidation of alcohols on Ni in alkaline solutions. While Fleischmann et al.^[11,26] assumed catalytic/intermediate role for NiOOH, others^[5] reported the methanol oxidation after conversion of Ni(OH)₂ to NiOOH in the course at anodic scan rates. Vertes and Horanyi^[27] criticized Fleischmann mechanism and giv-

ing rise the doubts on the role of NiOOH as an electro catalyst. In their research a new oxidation peak for the alcohol at a potential much more positive than oxidation potential of Ni(OH)₂ was obtained, where as the redox peaks has been unchanged.

Appearance of new oxidation peak at more positive than the oxidation potential of Ni(OH)₂ is due to elimination of methanol oxidation on the surface of oxide layer.

This mechanism is accompanied by oxidation of acetaminophen on the G/Ni electrode.

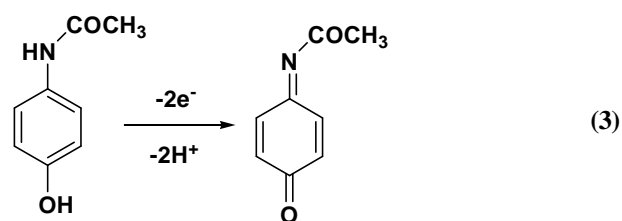

The redox transition of nickel species present in the film is given by:



Then methanol is oxidized on the modified surface via the following reaction

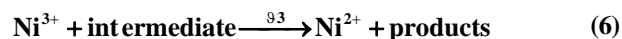
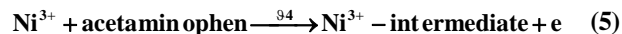

Where Ni³⁺ sites are regenerated by the power source and on the Ni³⁺ oxide surface by direct electro oxidation

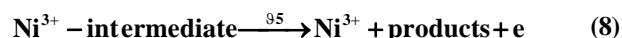
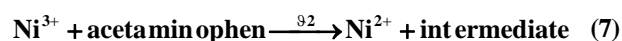

Equation (5) and (6) are according to Fleischmann mechanism and in equation (7) and (8), Ni³⁺ is used as active surface for methanol oxidation.

Methanol oxidation occurs at more positive potential than oxidation of Ni(OH)₂ according to equation (7) and (8). The above equation the Faradic current density can be written as:

$$I_F = (\text{v}_1 + \text{v}_4 + \text{v}_5)F \quad (9)$$

Figure 7 shows the Nyquist diagrams of Ni/NiOOH electrode at oxidation peak potential as dc-offset for some selected concentrations of acetaminophen. The Nyquist diagrams consisted of two slightly depressed overlapping capacitive semicircles in the high and low frequency sides of the spectrum. Whereas, the de-

Full Paper

pressed semicircle in the high frequency region can be related to the combination of charge transfer resistance and the double layer capacitance, the low frequency semicircle was attributed to the adsorption of reaction intermediate on the electrode surface.

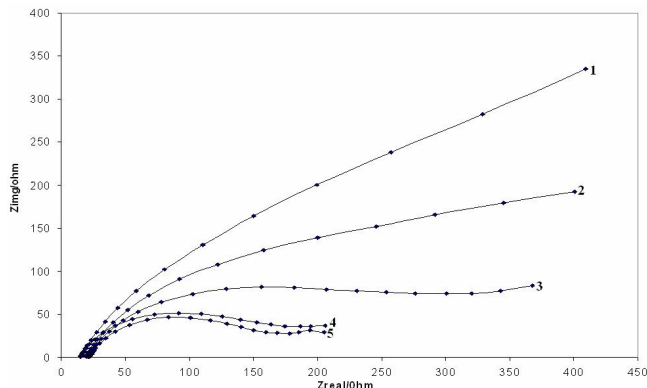

Figure 7 : Nyquist diagrams of Ni/NiOOH electrode in different concentration of acetaminophen in 1 M NaOH: (1) 0.1 M, (2) 0.3 M, (3) 0.5 M, (4) 0.7 M, (5) 0.9 M. DC potential is 450 mV/Ag,AgCl.

The equivalent circuit, corresponds to the Nyquist diagram in presence of acetaminophen, was depicted in Figure 8. To obtain a satisfactory impedance simulation of acetaminophen electro oxidation, it is necessary to replacing of the capacitor C with a constant phase element (CPE), Q , in the equivalent circuit is necessary. The most widely accepted explanation for the presence of CPE behavior and depressed semicircles on solid electrodes is microscopic roughness, causing an inhomogeneous distribution in the solution resistance as well as in the double-layer capacitance^[28]. In this electri-

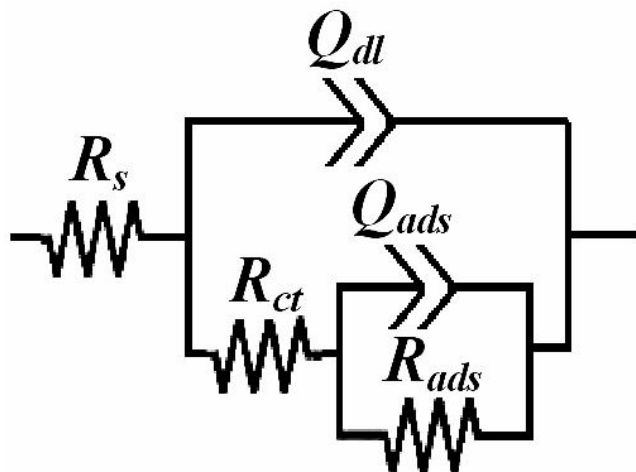

Figure 8 : Equivalent circuits compatible with the Nyquist diagrams in Figure 7 for acetaminophen electrooxidation on Ni/NiOOH electrode.

Research & Reviews On

Electrochemistry
An Indian Journal

cal equivalent circuit, R_s , CPE_{dl} , and R_{ct} represent solution resistance, a constant phase element corresponding to the double layer capacitance, and the charge transfer resistance, respectively. CPE_{ads} and R_{ads} are the electrical elements related to the adsorption of reaction intermediates. In this circuit the charge transfer resistance of the electrode reaction has a simple physical meaning and indicates how fast charge transfer occurs during methanol electro oxidation at the surface of the electrode.

In low applied overpotential, the current density of oxidation processes is related to Ni^{2+}/Ni^{3+} redox couple in presence of acetaminophen oxidation and it can be dispensed with equation (7) and (8).

In the above sequence of reactions equations, (3) to (5), k_1 and k_{-1} are obviously potential dependent rate constants and are of the forms:

$$k_1(E) = k_1^0 \exp\left[\frac{\alpha n F (E - E^0)}{RT}\right] \quad (10)$$

$$k_{-1}(E) = k_{-1}^0 \exp\left[\frac{(\alpha - 1) n F (E - E^0)}{RT}\right] \quad (11)$$

Where k^0 's are the chemical rate constants measured at equilibrium potential; α is the anodic symmetry factor and other parameters have their usual meanings. The rate laws for the reactions (3) to (5) have the forms of:

$$v_1 = k_1 \Gamma \theta_{II} - k_{-1} \Gamma \theta_{III} \quad (12)$$

$$v_2 = k_2 \Gamma \theta_{III} C^* \quad (13)$$

Where Γ is the total number of adsorption sites per unit area of the electrode surface; θ 's represent the fractional coverage's of different nickel valence states and C^* is the bulk concentration of methanol. If the (II) and (III) valence states of nickel meet the below conditions:

$$\theta_{II} + \theta_{III} = 1 \quad (14)$$

And the rates of changes of their coverage's as well as that of the intermediate compounds satisfy:

$$\frac{d\theta_{II}}{dt} = -\frac{d\theta_{III}}{dt} = -k_1 \theta_{II} + k_{-1} \theta_{III} + k_2 \theta_{III} C^* + k_3 \theta_{III} C_i \quad (15)$$

$$\frac{dC_i}{dt} = k_2 \theta_{III} C^* - k_3 \theta_{III} C_i \quad (16)$$

Where C_i is the concentration of the intermediate.

By assuming that the steady state approximations dominate:

$$\frac{d\theta_{II}}{dt} = -\frac{d\theta_{III}}{dt} = 0 \quad (17)$$

$$\frac{dC_i}{dt} = 0 \quad (18)$$

One arrives at the values of the coverage's:

$$\theta_{II} = \frac{(k_{-1} + 2k_2C^*)}{(k_1 + k_{-1} + 2k_2C^*)} \quad (19)$$

$$\theta_{III} = \frac{k_1}{(k_1 + k_{-1} + 2k_2C^*)} \quad (20)$$

On the basis of this rate equation, the faradic current will be:

$$i_f = \frac{2FAk_1\Gamma k_2C^*}{(k_1 + k_{-1} + 2k_2C^*)} \quad (21)$$

where A is the surface area of the electrode and the corresponding charge transfer resistance is given by:

$$R_{ct} = \left(\frac{di_f}{dE} \right)^{-1} = \left[\frac{(k_1 + k_{-1} + 2k_2C^*)^2}{2FA\Gamma k_2C^* k_1 \left(\frac{2\alpha F k_2 C^*}{RT} + \frac{k_{-1} F}{RT} \right)} \right] \quad (22)$$

The dependence of R_{ct} on the acetaminophen concentration is presented in Figure 9, where an initial sharp drop is terminated with a very slow change as the concentration of acetaminophen is reached to 9mM. The results are further fitted to equation (22) to estimate the values of the rate constants. From equation (22), the values of the rate constants as $k_1=2.4 \times 10^{-5}$, $k_{-1}=6 \times 10^{-3}$ and $k_2=3 \times 10^{-3} \text{ cm}^3 \text{ mol}^{-1} \text{ s}^{-1}$ have been calculated.

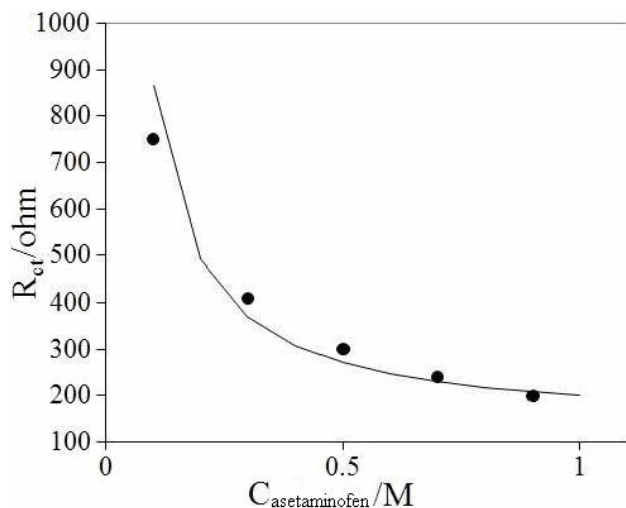

Figure 9 : Dependence of experimental R_{ct} (•) on acetaminophen concentration derived from the data of Nyquist diagrams.

CONCLUSION

The nickel oxide film was prepared electrochemically on electrodeposited nickel in cyclic voltammetry regime and tested for electro-oxidation of acetaminophen in alkaline media. The modified electrodes showed high electrocatalytic activity for the oxidation of acetaminophen around 400mV/. Moreover, the results showed effective response of acetaminophen electro-oxidation at the Ni/NiOOH modified electrode. The anodic peak currents for acetaminophen oxidation at Ni/NiOOH are linearly proportional to the square root of scan rate. Double steps chronoamperograms of Ni/NiOOH in presence of acetaminophen showed irreversible process and the dominance of a diffusion controlled process. The diffusion coefficient of acetaminophen has been obtained to be $3 \times 10^{-6} \text{ cm}^2 \text{ s}^{-1}$. The methods of cyclic voltammetry, chronoamperometry and impedance spectroscopy was used to determining of kinetic parameters such as transfer coefficient (α), the catalytic reaction rate constants (k), and the diffusion coefficient of acetaminophen in the bulk of solution.

ACKNOWLEDGEMENTS

The author would like to place on record, their appreciation for the support rendered by Iran Renewable Energy Initiative Council, on the research leading to the present article.

REFERENCES

- [1] B.Ameer, J.Greenblatt; Ann Int.Med., **87**, 202-2098 (1974).
- [2] Sebastian Griese, Dimitrios K.Kampouris, Rashid O.Kadara, Craig E.Banks; The Underlying Electrode Causes the Reported 'Electro-Catalysis' Observed at C_{60} -Modified Glassy Carbon Electrodes in the Case of N-(4-hydroxyphenyl)ethanamide and Salbutamol.
- [3] E.Antolini; Mater.Chem.Phys., **78(3)**, 563-573 (2003).
- [4] K.W.Park, J.H.Choi, B.K.Kwon, S.A.Lee, Y.E.Sung, H.Y.Ha, S.A.Hong, H.Kim, A.Wieckowski; J.Phys. Chem., **106(8)**, 1869-1877 (2002).
- [5] J.Taraszewska, G.Roslonek; J.Electroanal.Chem., **364(1-2)**, 209-213 (1994).

Full Paper

- [6] T.C.Wen, S.M.Lin, J.M.Tsai; *J.Appl.Electrochem.*, **24(3)**, 233-238 (1994).
- [7] C.Fan, D.L.Piron, A.Sleb, P.Paradis; *J.Electrochem. Soc.*, **141(2)**, 382-387 (1994).
- [8] I.A.Raj, K.I.Vasu; *J.Appl.Electrochem.*, **20(1)**, 32-38 (1990).
- [9] M.A.Casadei, D.Pletcher; *Electrochim.Acta*, **33(1)**, 117-120 (1988).
- [10] S.Berchmans, H.Gomathi, G.Prabhakara Rao; *J.Electroanal.Chem.*, **394(1-2)**, 267-270 (1995).
- [11] M.Fleischmann, K.Korinek, D.Pletcher; *J.Electroanal.Chem.*, **31(1)**, 39-49 (1971).
- [12] R.M.Van Effen, D.H.Evans; *J.Electroanal.Chem.*, **103(3)**, 383-397 (1979).
- [13] A.J.Motheo, S.A.S.Machado, F.J.B.Rabelo, J.R.Santos Jr.; *J.Braz.Chem.Soc.*, **5(3)**, 161-165 (1994).
- [14] J.M.Marioli, P.Luo, T.Kuwana; *Anal.Chim.Acta*, **282(3)**, 571-580 (1993).
- [15] J.M.Marioli, T.Kuwana; *Electroanalysis*, **5(1)**, 11-15 (1993).
- [16] S.Trasatti (Ed.); 'Electrodes of Conductive Metallic Oxides, Part B', Elsevier, New York (1980).
- [17] K.C.Khulbe, R.S.Mann, A.Manoogian; *Chem.Rev.*, **80(5)**, 417-428 (1980).
- [18] A.A.El-Shafei; *J.Electroanal.Chem.*, **471(2)**, 89-95 (1999).
- [19] G.W.D.Briggs, P.R.Snodin; *Electrochim.Acta*, **27(5)**, 565-572 (1982).
- [20] F.Hahn, B.Beden, M.G.Croissant, C.Lamy; *Electrochim.Acta*, **31(3)**, 335-342 (1986).
- [21] J.Desilvestro, D.A.Corrigan, M.J.Weaver; *J.Electrochem.Soc.*, **135(4)**, 885-892 (1988).
- [22] R.Barnard, C.F.Randell; *J.Appl.Electrochem.*, **13(1)**, 89-95 (1983).
- [23] A.J.Bard, L.R.Faulkner; 'Electrochemical Methods'. Wiley, New York, 591 (2001).
- [24] I.Danaee, M.Jafarian, F.Forouzandeh, F.Gobal, M.G.Mahjani; *International Journal of Hydrogen Energy*, **34(2)**, 859-869, January (2009).
- [25] K.C.Khulbe, R.S.Mann, A.Manoogian; *Chem.Rev.*, **80(5)**, 417-428 (1980).
- [26] M.Fleischmann, K.Korinek, D.Pletcher; *J.Chem. Soc., Perkin Trans.*, **2(10)**, 1396-1402 (1972).
- [27] A.J.Bard, L.R.Faulkner; 'Electrochemical Methods, Fundamentals and Applications'. In: A.J.Bard, (Ed.), Chap. 5, Wiley, New York, 209 (2001).
- [28] J.Losada, I.del Peso, L.Beyer; *J.Electroanal.Chem.*, **447**, 147 (1998).