

2014

BioTechnology

An Indian Journal

FULL PAPER

BTAIJ, 10(24), 2014 [15504-15517]

Study on extraction of image features of detection and location based on video motion nuclear method

Wang xiaojun*, Pan feng, Wang weihong

Physical Education College of Sichuan University, Si Chuan University,
Cheng du 610064, (CHINA)

ABSTRACT

Moving target detection and tracking algorithm research content is very broad and complex applications, without and different target features directly affects the detection of selected tracking algorithm. So far still does not exist a universal algorithm for perfect can be suitable for various applications, so the detection and tracking of moving targets is still a valuable research subject of. The research work in this paper is in the field, the moving target detection spatiotemporal correlation and difference contour tracking algorithm based on a fixed background. The algorithm in the background under the condition of fixed to pay a smaller time complexity, the target detection and tracking has a good effect, so it has higher application value. Based on solving the detection and location of moving target tracking in real-time and accuracy requirements, a new moving target detection spatiotemporal correlation and difference contour tracking scheme based on the practical implementation, at the same time analysis and the experimental results are given. In the moving target tracking, tracking method is mainly traditional correlation method target based on template matching. The matching process is time consuming, so the actual use of more of the improved algorithm of correlation method, the improved algorithm attempts to improve the efficiency of feature matching and search range, and also achieved a certain effect, the some excellent tracking algorithm. This paper presents an improved active contour model tracking algorithm, improve the tracking efficiency and quality, the algorithm first from the frame difference detection results to find the moving target coarse contour, and then the convergence of coarse contour by using improved Snake algorithm, the right edge to get the target in the course of the campaign, in order to achieve the tracking of moving objects.

KEYWORDS

Moving object; Detection; active; Pattern recognition; Image features.



INTRODUCTION

In real life, most of us meaningful information of vision are included in sports. Although human vision can see the movement of objects and can see stationary objects, but in many occasions, such as video surveillance of the banking system, automatic detection of traffic flow measurement, aviation and military aircraft guidance and so on, people often only on the moving object of interest. So the development of intelligent machines to assist or replace the human work, give the machine to human visual function on the development of intelligent system is extremely important. Aviation and military aircraft guidance and so on, people tend to focus on the moving object of interest. Visual motion analysis is a hot topic in recent years, research in the field of computer vision, which comprises a detection from image sequences and moving object segmentation, object recognition, the target classification and the moving target tracking and behavior understanding and description of image analysis and understanding, which belongs to the category^[1].

Motion analysis is quite rich, mainly related to pattern recognition, image processing, computer vision, artificial intelligence and other disciplines of knowledge^[2]. But at the same time, the fast segmentation of moving objects in dynamic scenes, between the non rigid motion object occlusion or stop treatment for motion analysis has brought some challenges^[3]. Visual motion analysis is a hot topic in recent years, research in the field of computer vision, which comprises a detection from image sequences and moving object segmentation, object recognition, the target classification and the moving target tracking and behavior understanding and description of image analysis and understanding, which belongs to the category of. Motion analysis is quite rich, mainly related to pattern recognition, image processing, computer vision, artificial intelligence and other disciplines of knowledge. But at the same time, the fast segmentation of moving objects in dynamic scenes, between the non rigid motion object occlusion or stop treatment for motion analysis has brought some challenges^[4,5]. The detection and location of moving object tracking in image sequences of military, has important significance on science and industry, has a very attractive prospect. In the military, a no-load visual system such as the satellite system to low altitude and ground target surveillance and low altitude or ground system to air target detection and tracking, in the civil, often with alarm system together to complete the detection and tracking of invasion target; in addition also widely used in virtual reality environment, simulation training, automatic navigation, robot target acquisition^[6].

Behavior understanding and description of objects is a hot research topic in recent years has been widely concerned, it refers to the movement pattern analysis and recognition, and natural language description^[7]. Behavior understanding can be simply considered to be time-varying data classification problem, matching reference sequence to the test sequence and the pre calibration of the representative the typical behavior^[8]. Therefore, the key problem is how to obtain the reference behavior understanding behavior from the learning sample sequence, and learning and behavior sequence matching can handle the space in the category similar movement patterns and time scale of minor changes. Target classification is the purpose of moving objects from the detected moving regions will be needed to study or our interest region extracted^[9]. Various motor regions may correspond to different moving objects such as pedestrians, may contain image sequences of traffic on the road monitoring camera captures, vehicles and other such as birds, clouds, shaking the branches and other moving objects, and in these objects, we are only interested in one of the vehicles. Therefore, in order to further analyze and tracking behavior for a specific target, the correct classification of moving targets is very necessary^[10-12].

The main task of moving object detection and tracking system is from a series of images in the detection of target information, and obtain the motion parameters, the corresponding algorithm adjusted, so as to realize the control console to complete the task of target tracking. This is a real-time system, it requires the system to real-time image acquisition, real-time data processing, real-time data storage, including technical difficulties are mainly two: the first is how to complete the processing of large amounts of data in limited time; the second is how to in a complex background (natural disturbance and artificial interference detection) and tracking of moving objects accurately. The experimental results show that, this method can effectively suppress noise in the target detection, moving target and extract the target point more to detect more complete, so it is practical, in the object tracking, not by matching

and search based on the traditional, but the inter frame difference results obtained from the edge as the Sflake algorithm control contour line, through the Snake algorithm to improve the motion target tracking, real-time and accuracy.

RELATED WORK

Image sequence analysis

Image sequence is also known as dynamic image^[13], image sequence which is composed of a series of relative with the given or assumption of the composition, and gives the adjacent image acquisition time interval between the generally can be expressed as follows:

$$B_0(x, y) \square N(\mu_0, \sigma^2) \quad (1)$$

$$\sigma_0^2(x, y) = \frac{1}{M} \sum_{k=0}^{M-1} [f_k(x, y) - \mu_0(x, y)]^2 \quad (2)$$

$$\mu_0(x, y) = \frac{1}{M} \sum_{k=0}^{M-1} f_k(x, y) \quad (3)$$

In order to facilitate the analysis^[14], we first consider the one-dimensional space and time coordinates, as shown in Figure 1, stationary target gray structure for the vertical direction, and a moving target will frame for mobile, gray sloping structure, it is directly extended to 3D spatio-temporal image sequence.

Effect of Peng expansion in mathematical morphology is the object near the background point into the object. It is the value of the two target boundary points were expanded, all the background will contact with the target into the goal, process the boundary to external expansion. If the distance between two objects is close, so through the expansion operation makes them into a connected region, which is very useful to fill empty after image segmentation in the target. The collection of Z A and B, on the A corrosion using B, AOB, defined as:

$$A \ominus B = \{z | (B)_z \subseteq A\} \quad (4)$$

Dilation and erosion for collection and operation and inverse operation are duals of each other, that is

$$(A \ominus B)^c = A^c \oplus \hat{B} \quad (5)$$

Statistical average method based on the continuous image sequence pixel by pixel statistical average, the average values to approximate the background image, both continuous acquisition of N image cumulative average:

$$B_k = \frac{1}{N} (f_k + f_{k-1} + \dots + f_{k-N+1}) \quad (6)$$

Where N is the image frames, motion velocity value and moving target N and target size, moving faster, more small, can obtain the background with fewer frames, general N bigger and more beneficial to get more realistic background estimation.

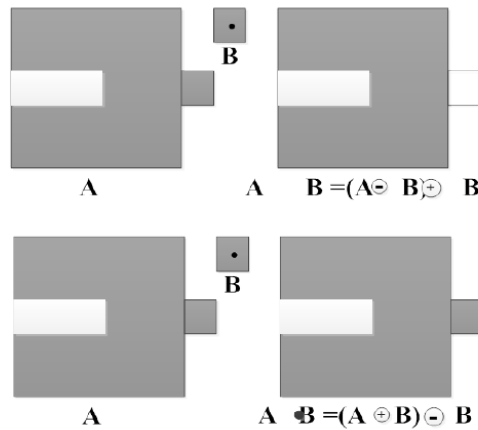

Figure 1: The one-dimensional space and time coordinate

Morphological analysis of digital image

In recent years, mathematical morphology has been widely used in digital image processing and machine vision field, forming a unique digital image analysis method and theory. Mathematical morphology is the language of set theory, it is built on the basis of set algebra, set theory method with a quantitative description of the geometric structure of science^[15].

Because the mathematical morphology has a complete mathematical basis, which used to analysis and processing for morphological^[16,17]. The solid foundation for design analysis and mathematical morphology filter, especially prominent is the realization of a morphological analysis and parallel processing algorithm, greatly improving the image analysis and processing speed. Usually morphological image processing is a neighborhood operation form, a special definition of neighborhood called / structural elements. Morphological image processing operation is method for two value image according to the set of mathematical morphology theory developed, morphological operation basically has four kinds: dilation, erosion, opening and closing operations^[18].

$$F = \begin{cases} \theta & \text{if } (G \geq B) \\ 2\pi - \theta & \text{if } (G \leq B) \end{cases} \tag{7}$$

$$\theta = \cos^{-1} \frac{\frac{1}{2}[(R - G) + (R - B)]}{[(R - G)^2 + (R - B)(G - B)]^{\frac{1}{2}}} \tag{8}$$

From HIS to RGB transformation formula is somewhat different, it depends on the conversion of the point where the color ring.

When $0^\circ \leq H \leq 120^\circ$:

$$R = \frac{I}{\sqrt{3}} \left[1 + \frac{S \cos(H)}{\cos(60^\circ - H)} \right], B = \frac{I}{\sqrt{3}} (1 - S), G = \sqrt{3}I - R - B \tag{9}$$

When $120^\circ \leq H \leq 240^\circ$:

$$G = \frac{I}{\sqrt{3}} \left[1 + \frac{S \cos(H - 120^\circ)}{\cos(80^\circ - H)} \right], R = \frac{I}{\sqrt{3}} (1 - S), B = \sqrt{3}I - R - G \tag{10}$$

When $240^\circ \leq H \leq 360^\circ$:

$$B = \frac{I}{\sqrt{3}} \left[1 + \frac{S \cos(H - 240^\circ)}{\cos(300^\circ - H)} \right], G = \frac{I}{\sqrt{3}} (1 - S), R = \sqrt{3}I - G - B \quad (11)$$

$$MSE(i, j) = \frac{1}{M \cdot N} \sum_{m=1}^M \sum_{n=1}^N [T(m, n) - F(m + i, n + j)]^2 \quad (12)$$

$$MPC(i, j) = \sum_{m=1}^M \sum_{n=1}^N N(i, j) \quad (13)$$

In it:

$$M(i, j) = \begin{cases} 1 & \dots \dots \dots |T(m, n) - B(m + i, n + j)| < t \\ 0 & \dots \dots \dots \text{others} \end{cases} \quad (14)$$

Moving target detection and tracking

(a) Background capture and estimation

Moving target detection and segmentation of the object is separated from the background in the image sequence, moving target, accurate moving object segmentation from video image is the object classification, tracking, feature extraction and pattern matching processing base. But due to the dynamic change of background image, such as the weather, illumination, shadow effects, makes the motion detection is a very difficult job.

Background compensation method based on movement of moving object in motion relative to the background scene position to change, namely the moving target can move from one location to another scene. At the moment of K state, moving target covering one part of the background, but changes with the movement position of moving target, covered by a K time background will be in later time gradually revealed. So that you can use the K moments later revealed background to compensate K moments are covered in the background, so as to obtain the background information of the entire scene K moments.

Image sequence formed by the moving object can be divided into two types: one is the static background pressure, another is the background of the movement. One occurred in a state of relative rest in the camera and scene, the latter occurring in the camera and scene relative motion applications. From the processing methods, the moving target can be used to highlight the target or eliminate background two ideas to the test. In the static background, can be eliminated by the method of target detection in the background, and the moving background is to deal with more complex, if using the method to eliminate the background inter-frame registration method, if the target, then the need for multi frame registration under the premise of energy accumulation and noise suppression.

(b) The basic method of moving target detection

For many applications a said, continuous difference image detection in image sequences is a very important step. Any observable motion in the scene will be reflected in the changes in image sequences, if can detect such changes, we can analyze the motion characteristics. Further, if the target's motion constraints in a plane parallel to the image plane, good estimation can be quantitative parameters of the target motion characteristics. The two adjacent frame difference image basic process principle was shown in Figure 2.

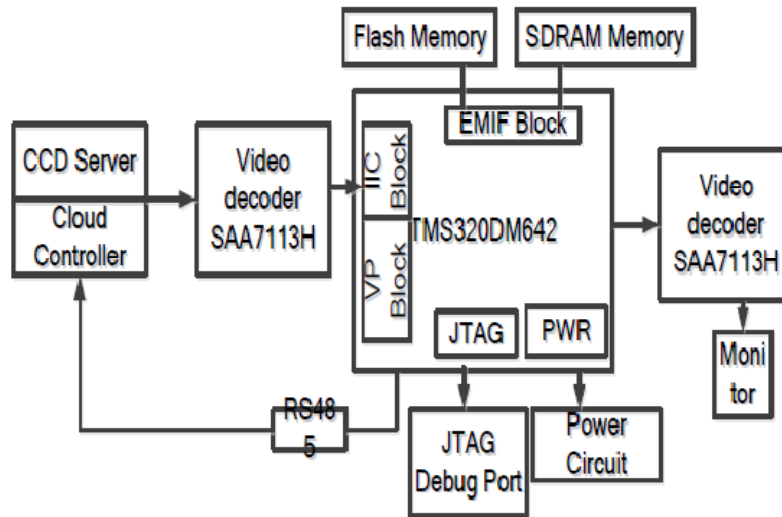

Figure 2: The two adjacent frame difference image basic process principle

(c) Moving target feature extraction and search algorithm

Feature extraction is an important part of target tracking, target the extracted features must be able to complete characterization of target, especially in the change of ambient light or target's deformation, caused by the movement of change, will still be able to describe the target. According to the research object and the environmental target feature suitable selection is a very important step, feature of objects in image can be divided into:

- (1) Visual features of images, such as image color, edge, shape, texture and region features
- (2) The statistical characteristics of image, such as color histogram, moment invariants features
- (3) Transform coefficients feature of image, such as Fu Liye described the characteristics of wavelet transform coefficients

EXTRACTION OF IMAGE FEATURES BASED ON VIDEO MOTION NUCLEAR METHOD

The spatial correlation of the block differential detection

According to the research purpose and object oriented in different color space, can use different color model to characterize and describe, in which RGB model and HIS model are more common. The former is mainly used for color image acquisition. Display and transmission hardware equipment, the latter with the human visual system should be relative, image processing and computer vision research for algorithm.

For the target tracking algorithm, the motion detection function by the compensation of the background frame difference method based on characteristic information of gray histogram, the establishment of template function through the extraction of target.

RGB to HIS around is a simple and fast nonlinear transform, the normalized RGB, its mathematical conversion relations are as follows:

$$Avgarea_m = \frac{\sum_{k=1}^N S_k}{N} \tag{15}$$

$$Q_k(x,y) = \begin{cases} 0 & S_k > Avgarea_m \\ 1 & S_k \leq Avgarea_m \end{cases} \tag{16}$$

$$\begin{bmatrix} Y \\ U \\ W \end{bmatrix} = \begin{bmatrix} 0.399 & 0.567 & 0.124 \\ -0.269 & -0.3326 & 0.530 \\ 0.510 & -0.418 & -0.0833 \end{bmatrix} \begin{bmatrix} R \\ G \\ B \end{bmatrix} \quad (17)$$

A histogram is a variety of spatial processing technology foundation. Histogram operation can be effectively used for image enhancement, image segmentation and compression, enhancement in the field of image, can be through the development of a transform function, this function only depend on the input image histogram information can be automatically image gray level distribution is very narrow into a high contrast and changeable image gray tone, so as to achieve the effect of image enhancement.

The differential motion target tracking

Continuous image sequence of target motion is produced with strong spatiotemporal correlations. The time correlation with the great similarity between the two adjacent frame image, change little. One is very close in color, have similar brightness or texture feature, if the two frames subtraction continuously, can be found in the majority of the two frame image pixel color values and color information lost, become black.

This indicates that, after the color of an image pixel values can be replaced without great influence with the previous image frame corresponding to the position of pixel values; two is the region close to, if in the previous frame image in a pixel belongs to the foreground part, then according to the time correlation can also be seen in an image frame the corresponding pixel belongs to the foreground part position. The spatial correlation of neighboring pixels is refers in the image of one frame is very similar, changes slowly. Also, this similarity is also reflected in the color is very close to the same and regional division of these two aspects.

$$Q(k+1) = AS(k) + w(k) \quad (18)$$

$$Q(k) = [px(k), vx(k), py(k), vy(k)]^T \quad (19)$$

Video image sequence has spatial correlation and temporal correlation, practical applications using the finite difference method to extract the small moving target from complex background, often occur in large gaps in the moving target and background color close to the area, so as to reduce test quality. If we consider the temporal and spatial correlation in the moving target detection process, can reduce the phenomenon of missing small targets in complex background related.

$$v(k) = [0, u1(k), 0, u2(k)]^T \quad (20)$$

$$B = \begin{pmatrix} 1 & T & 0 & 0 \\ 0 & 1 & 1 & 0 \\ 0 & 1 & 1 & T \\ 0 & 0 & 0 & 1 \end{pmatrix} \quad (21)$$

$$P(k) = E[w(k)w^T(k)] = \begin{pmatrix} 0 & 0 & 0 & 0 \\ 0 & 0 & \sigma_1^2 & 0 \\ 0 & 0 & 0 & 0 \\ 0 & 0 & 0 & \sigma_2^2 \end{pmatrix} \quad (22)$$

$$V(k) = E[v(k)v^T(k)] = \begin{pmatrix} \sigma_x^2 & 0 \\ 0 & \sigma_y^2 \end{pmatrix} \tag{23}$$

EXPERIMENTAL RESULTS

Overview of experimental model algorithm

Kernel principal component analysis (KPCA) method based on the validation of the KPCA is much better than PCA in the nonlinear analysis problem. Then, there are a lot of linear analysis method, for nuclear, much to deal with the nonlinear problems: linear Fisher differential nucleation by Kernel Fisher Discriminant (KFDA), linear regression method and typical component analysis is extended to the kernel feature space, the kernel ridge regression were obtained (KRR) and kernel canonical correlation analysis (KCCA). Kernel methods have been widely applied in many fields of text classification, face recognition, time series prediction. Nowadays, kernel method is the most commonly used is SVM, KPCA and KFDA, which introduces the three kernel method.

Two dimensional linear non separable problem can be mapped to the 3D feature space linear can be divided was shown in Figure 3.

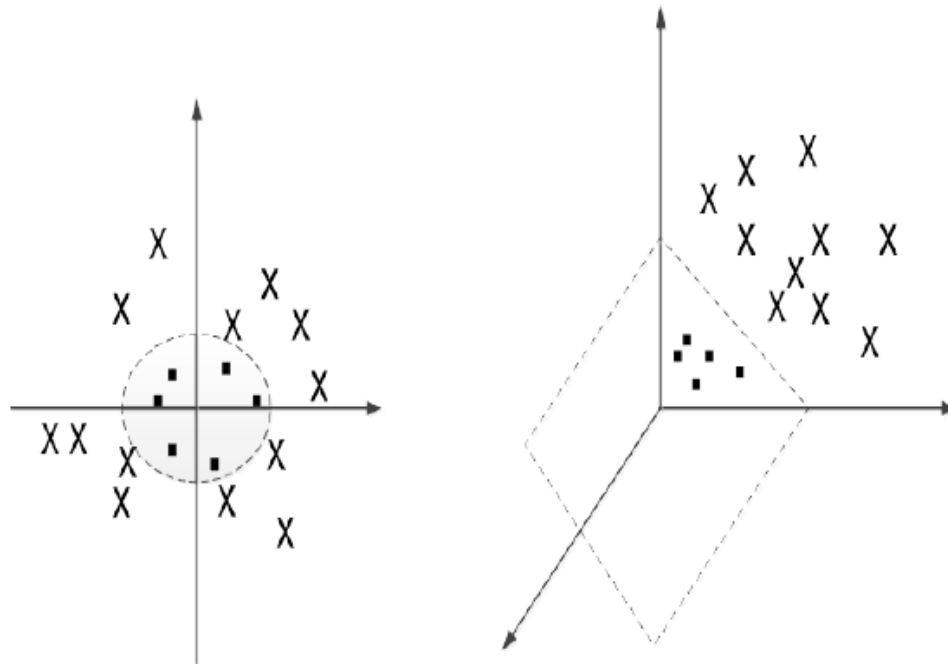

Figure 3: Two dimensional linear non separable problem can be mapped to the 3D feature space linear

Describe the main algorithm experimental model

The effects of group experience on the motion of particles, the best position to find individual particle to particle swarm. Acceleration of d1 and d2 can also be called a learning factor, the parameters are used to adjust the particle's own experience and group experience play role during exercise, on behalf of the statistical particle recommended pbest and gbest position acceleration term weight, d1=d2=1.50 or 2. In the improved PSO algorithm, there are some algorithms is to make O or d1, d2, the value of d adaptive changes, the improved PSO global in the iterative process of preliminary search ability is strong, the iterative process in the local search ability. The standard particle swarm optimization algorithm flow chart is shown in Figure 4.

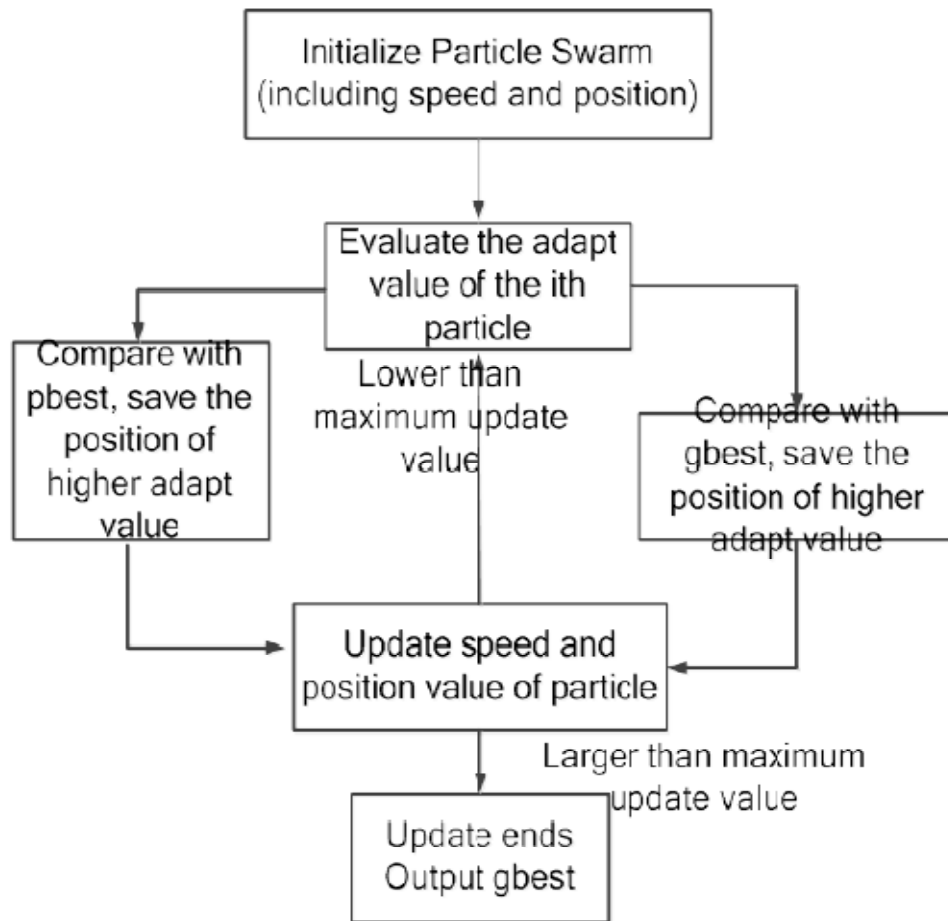

Figure 4: The standard particle swarm optimization algorithm flow chart

The two form of kernel function and compared to a conventional, such as the Gauss kernel function, Gauss function is to satisfy all constraints in two forms, that is to say, the feature weighting coefficients of the same order in the form of fixed, higher order characteristics of different order characteristic of low order and its corresponding and satisfy the exponential form, only by a kernel function -- nuclear width to determine the RKHS, decided to high dimensional feature mapping contact form.

Compared to the GF space GF with polynomial kernel function space of polynomial kernel function and constraints, the computational complexity is too high. But according to actual condition, can choose different conditions, when the dimension of the samples is not high and the same order of different samples intrinsic differences can choose the first condition, when the dimension of the samples is too high and the different samples with different order characteristic difference is larger, can consider second kinds of constraints. Figure 5 is the unrestricted conditions of GF space model polynomial kernel classification.

The double helix classification is usually used to performance test of pattern recognition algorithms, the plane coordinate form of double spiral can be used to represent the parameter equation as follows:

$$\begin{cases} x_1 = (a_1\theta + e_1)\cos(\theta) \\ y_1 = (a_1\theta + e_1)\sin(\theta) \end{cases} \quad (24)$$

$$\begin{cases} x_2 = (a_2\theta + e_2) \cos(\theta) \\ y_2 = (a_2\theta + e_2) \sin(\theta) \end{cases} \quad (25)$$

Among them, a_1 , a_2 , e_1 and e_2 are parameters to be set. In the experiment, θ is the random number and interval.

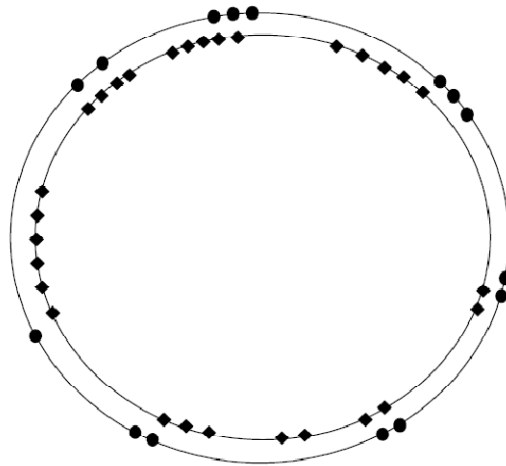

Figure 5: The unrestricted conditions of GF space model polynomial kernel classification

The system is based on the characteristics of the target object, we use the target tracking algorithm based on Kalman prediction features and combines.

Mean Shift target tracking algorithm complete process is shown in Figure 6. In advance by the above algorithm, Mean Shift algorithm can be regarded as the iterative process from Y_0 to Y_1 moving process, each Mean Shift vector to determine a mobile, and the similarity measure function value increases, eventually reached the maximum similarity function.

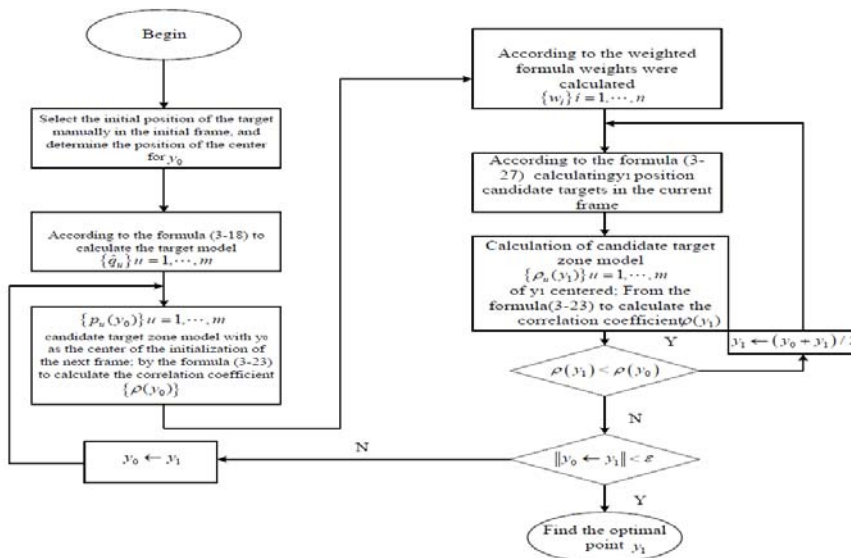

Figure 6: Mean Shift target tracking algorithm complete process

Feature-based target tracking algorithm is simple and is conducive to the DSP embedded platform, while knot Kalman filter algorithm combines the prediction of the motion range of the target may occur in the next frame, the amount of computation is reduced, but also has good tracking. As shown in Figure 7 target tracking algorithm flow for this article, in which motion detection function-based compensation background frame difference method to achieve, through the establishment of a template function in the histogram feature information extraction goals.

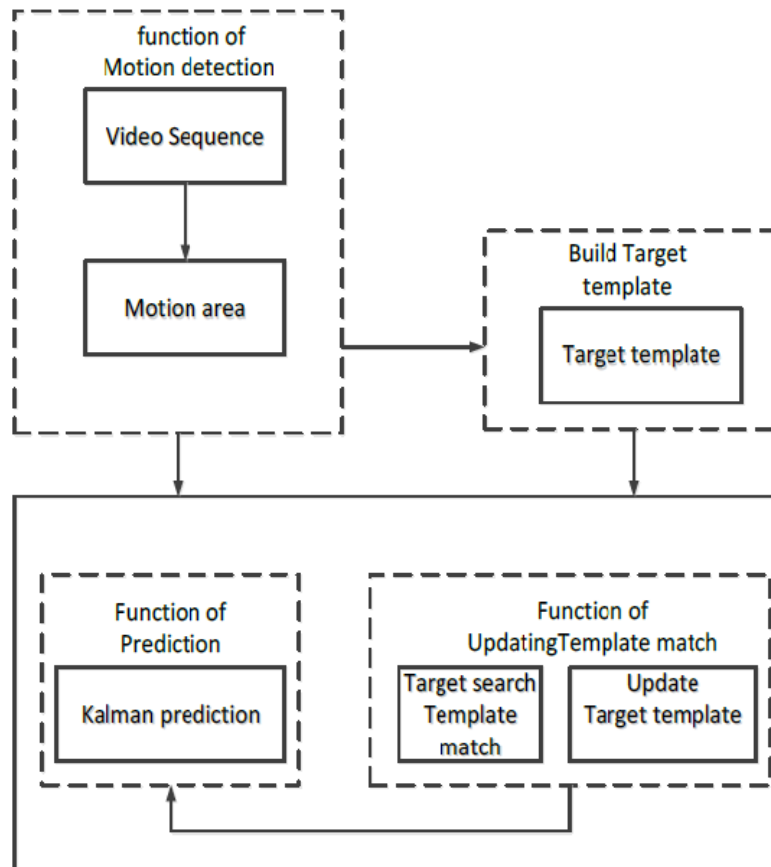

Figure 7: Target tracking algorithm flow

Simulation results and analysis

In practical applications, due to various factors, the algorithm can not be completely separated foreground accurately compare a light separated by the naked eye without movement of the target image is not intuitive science. Therefore, in order to quantify the performance differences between different parameters, use the following were positive detection rate (R), the detection rate (P), F measure (F) and similarity (S) of these four indicators to measure the performance of various detection algorithms processing results. Positive detection rate is the ratio of the number of correct detection of the target pixel and the total number of pixels, the higher the rate being representative of the subject, the less erroneous detection pixels; detecting the detection rate is the ratio of total number of pixels with the correct number of pixels in the real target object detection the higher rate represents more correctly detected pixels; F measure and similarity are complementary positive detection rate and the detection rate is a comprehensive evaluation of the positive detection rate and detection rate, the greater its value represents the number of pixels of false detection and the number of pixels and missed fewer. Moving object detection in outdoor scenes was shown in Figure 8.



Figure 8: Moving object detection in outdoor scenes

Difference moving target positioning contour tracking experiment on smart image a jump in the video tracking based on the location, and using the block in front of the background difference method to the first frame motion object is extracted as the image sequence tracking back to the initial template. Figure 9 shows the first frame motion the target template extracted, the second frame image moving target coarse contour difference contour extracted, and generates the control point algorithm set, extract the control point step size of 10 pixel, the frame image extraction to a total of 22 control points.

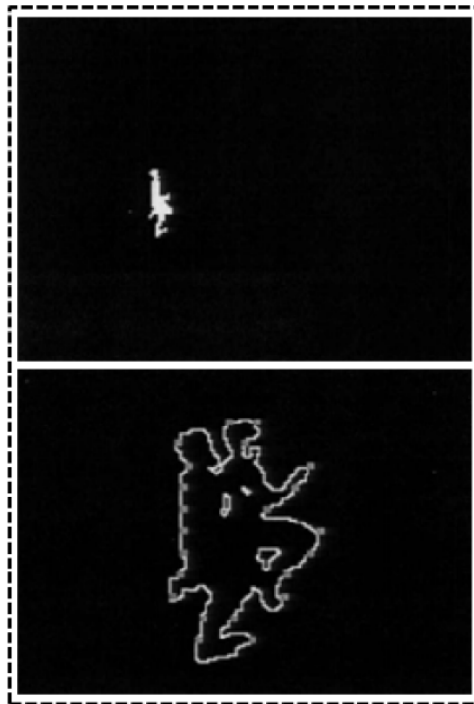

Figure 9: The first frame motion target template extracted, the second frame image moving target coarse contour difference contour extracted

Video moving target detection and feature extraction is an important research content in computer awareness, in order to reduce the computational complexity, extended the polynomial kernel function of two kinds of constraints, respectively in the same order difference characteristics and different characteristics of order. The histogram of pixel distribution was shown in Figure 10.

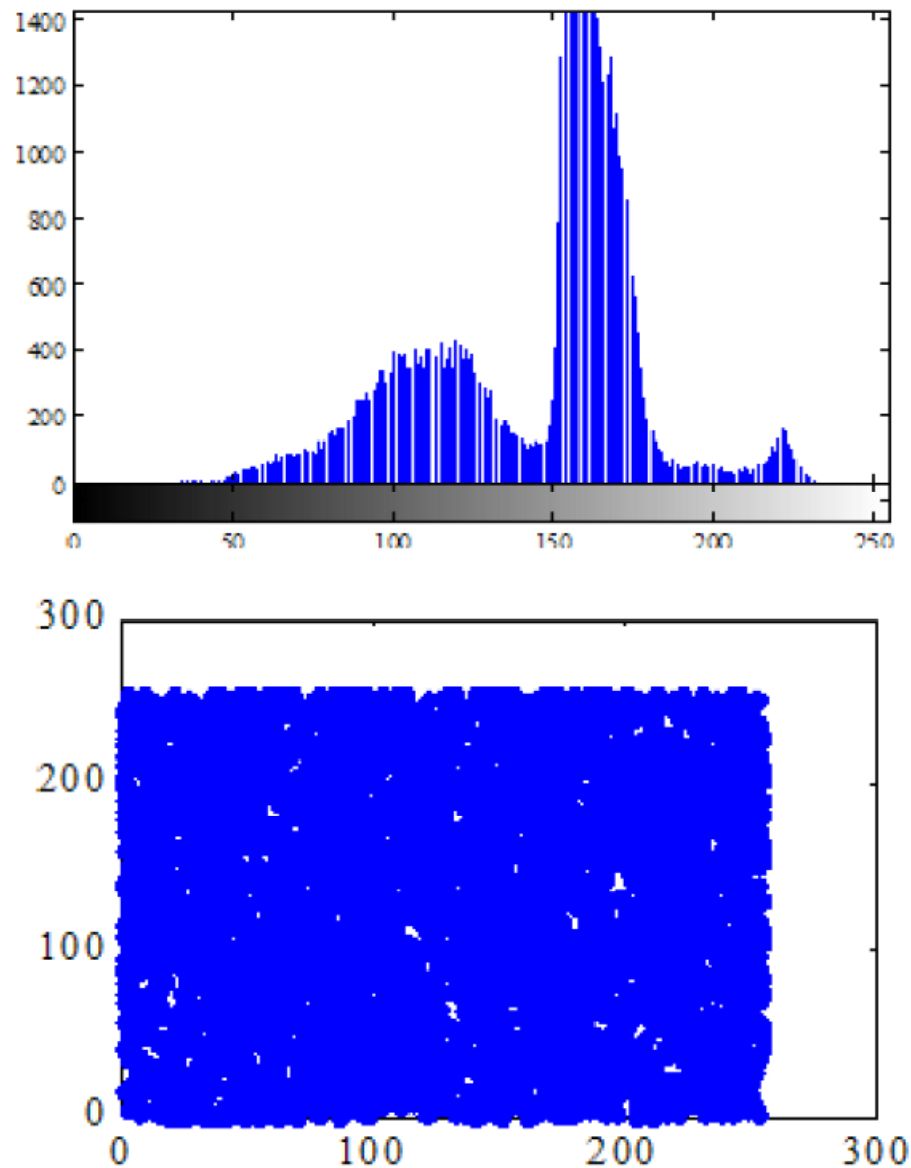

Figure 10: The histogram of pixel distribution

Moving target detection and tracking algorithm research content is very broad and complex applications, without and different target features directly affects the detection and tracking algorithm "so far still does not exist a general improvement can be suitable for various applications in the field of numerical method, so the detection and tracking of moving targets is still a valuable research subject of" in recent years, the video surveillance application is more and more widely, people are not satisfied with the goal of monitoring, and the video monitoring technology of intelligent video moving object detection and tracking technology has received extensive attention.

CONCLUSIONS

In this thesis, moving target detection and tracking algorithms are studied, first introduced the video moving target detection and tracking of development, significance, principles and methods, and relevant background knowledge introduced. Including assumptions and external motion constraints and environmental constraints hypothetical target detection and tracking system used; main target detection algorithm is used, including static images and moving target detection target detection; common target tracking technology basics, the target of four kind of representation. Taking into account the background will change over time and change, for example, lead to changes in brightness of the background illumination, color change, moving objects, such as stop motion becomes part of the background, describes three common background updating method. Meanwhile paper presents an improved target detection and background subtraction combination of frame difference, and this improved algorithm for the simulation, by comparison with the first two methods, this algorithm can get better image detection results.

REFERENCES

- [1] Tiejun Wang, J.G.Proakis, E.Masry, J.R.Zeidler; "Performance degradation of OFDM systems due to Doppler spreading", IEEE Transactions on Wireless Communications, **5**, 1422 – 1432 (2006).
- [2] T.Fusco, M.Tanda; "ML frequency offset and carrier phase estimation in OFDM systems with noncircular transmissions," in Proc. EUSIPCO 2004, 897–900 (2004).
- [3] Changyong Shin, W.Jr.Robert, Edward J.Powers; "Blind Channel Estimation for MIMO-OFDM Systems", IEEE Transactions on Vehicular Technology, **56**, 670-685 (2007).
- [4] C.Dubuc, D.Starks, T.Creasy, Y.Hou; "A MIMO-OFDM prototype for next-generation wireless WANs", IEEE Commun.Mag., **42(12)**, 82–87 (2004).
- [5] A.van Zelst, T.C.W. Schenk; "Implementation of a MIMO OFDM-based wireless LAN system," IEEE Trans. Signal Process., **52**, 483–494 (2004).
- [6] G.L.Stüber, J.R.Barry, S.W.Mclaughlin, Y.Li, M.A.Ingram, T.G.Pratt; "Broadband MIMO-OFDM wireless communications", Proc.IEEE, **92(2)**, 271–294 (2004).
- [7] Wang Xin, Tan Zhen-hui, Chen Xia; "Doppler diversity receiver for broadband wireless OFDM system under high-speed mobile environments", IEEE International Symposium on Microwave, Antenna, Propagation and EMC Technologies for Wireless Communications 2005, **2**, 1444 – 1447 (2005).
- [8] Chen Donghua, Qiu Hongbing; Doubly selective channel estimation for subband and OFDMA using basis expansion models.
- [9] Q.H.Spencer, A.L.Swindlehurst, M.Haardt; "Zero-Forcing Methods for Downlink Spatial Multiplexing in Multiuser MIMO Channel", IEEE Transactions on Signal Processing, **52(2)**, 461-471 May (2004).
- [10] M.Sadek, A.Tarighat, A.H.Sayed; "A Leakage-based Precoding Scheme for Downlink multi-user MIMO Channels", IEEE Transactions on Wireless Communications, **26(8)**, 1505-1515 (2008).
- [11] A.Tarighat, M.Sadek, A.H.Sayed; "A multi User Beamforming Scheme for Downlink MIMO Channels based on Maximizing Signal-to-Leakage Ratios", IEEE International Conference on Acoustics, Speech, and Signal Processing, 1129-1132 (2005).
- [12] Li JianZhong, Li JinBao, Shi ShengFei; "Concepts, Issues and Advance of Sensor Networks and Data Management of Sensor Networks," Journal of Software, **14(10)**, 1717-1727 (2003).
- [13] S.Tilak, N.B.Abu-Ghazaleh, W.Heinzelman; "A Taxonomy of Wireless Micro-sensor Network models," Mobile Computing and Commuications Review, **1(2)**, 1-8 (2002).
- [14] David Culler, Deborah Estrin, Mani Srivastava; "Overview of Sensor Networks", IEEE Computer Society Officers, **11(10)**, 15-25 (2005).
- [15] T.Matsuo, Y.Kaneko, M.Matano; "Introduction of Intelligent Vehicle Detection Sensors", IEEE/IEEJ/JSAI International Conference on Intelligent Transportation Systems, **5(12)**, 709-713 (1999).
- [16] J.Deng, R.Han, S.Mishra; "Inrusion tolerance and Anti-traffic Analysis Strategies in Wireless Sensor Networks," IEEE 2004 International Conference on Dependable Systems and Networks, **10(11)**, 477-490 (2004).
- [17] Q.R.Li, L.Y.Wei, S.F.Ma; "The Model Analysis of Vehicles Situation and Distribution in Intersections Abased on Markov Process," IEEE International Conference on Intelligent Transportation Systems, **2(10)**, 1076-1080 (2003).
- [18] A.Wadaa, S.Olariu, L.Wilson, M.Eltoweissy, K.Jones; "On Providing Anonymity in Wireless Sensor Networks," 10th International Conference on Parallet and Distributed Systems, **5(10)**, 125-136 (2004).