



Journal of Physics & Astronomy

WWW.TSIJOURNALS.COM

Full Paper

G.M.El Aragi

Plasma Physics and Nuclear Fusion
Dept., Nuclear Research Center, AEA,
PO 13759 Cairo, (EGYPT)
E-mail: elaragi@gmail.com

*Corresponding author's
Name & Address

G.M.El Aragi
Plasma Physics and Nuclear Fusion
Dept., Nuclear Research Center, AEA,
PO 13759 Cairo, (EGYPT)
E-mail: elaragi@gmail.com

Pulsed cold plasma jet generated at atmospheric pressure

Abstract

Non-equilibrium cold plasma jets generated under atmospheric pressure by means of high voltage pulsed power generator are extended up to a few centimeters long in the surrounding air. The generator is consisting of a negative dc source, a Blumlein-type pulse-forming network (E-PFN), and a dynamic spark gap switch. The plasma jet generated by the device using helium as the operating gas depends on the applied voltage and the gas flow rate. It is found that the plasma jet width and the radiant intensity depend on the discharge current. The experimental results show that the average velocity of the plasma bullets is estimated to be about 5.5×10^6 cm/s. The magnetic field radiated from an atmospheric pressure room temperature plasma plume is measured. It's found that the peak value of the magnetic field strength about 900 gauss at 1cm away from the nozzle.

Key Words

Cold plasma; Atmospheric pressure; Spark gap switch; Discharge current.

INTRODUCTION

Atmospheric pressure non-equilibrium plasmas have become powerful experimental tools for many applications in areas such as micro fabrications in microelectronics^[1], surface modifications^[2], light sources^[3-4], and environmental processing^[5]. Cold atmospheric pressure plasma jet devices have recently attracted significant attention for food preservation^[6-7]. The most important devices for generating atmospheric pressure non-thermal plasmas can be considered: atmospheric pressure plasma jet^[8-9], plasma needle^[10], plasma pencil^[11-12], miniature pulsed glow-discharge torch^[13], one atmosphere uniform glow-discharge plasma^[14], resistive barrier discharge^[15] and dielectric barrier discharge^[16].

Atmospheric pressure non-equilibrium plasmas, which have an electron temperature that is much higher than gas temperature, have recently come to play an increasing role in several novel applications, such as biological applications^[17-18].

Non-thermal plasmas, operated at ambient atmospheric pressure and temperature, are very efficient sources for the production of highly reactive neutral particles, for ex-

ample, reactive oxygen and nitrogen species (RONS) (such as atomic oxygen, atomic nitrogen, hydroxyl radical, superoxide, singlet delta oxygen, and nitrogen oxides), charged particles, UV-radiation, and electromagnetic fields. Non-thermal plasmas are frequently called, "non-equilibrium" plasmas because they are characterized by a large difference in the temperature of the electrons relative to the ions and neutrals. Since the electrons are extremely light, they move quickly and have almost no heat capacity. In these plasmas, $T_e \gg T_i \approx T_n$. Ionization is maintained by the impact of electrons (which may have temperatures ranging from 0.1 to more than 20eV) with neutral species, producing additional electrons and ions. These plasmas are typically maintained by the passage of electrical current through a gas.

Due to the high collision frequency at atmospheric pressure, it is not easy to generate a long non-equilibrium plasma plume at atmospheric pressure. Furthermore, studies on the fundamentals of plasma plumes show that plasma plumes are not a continuous volume of plasma; rather, plumes are more like a bullet formed by a small and well-confined plasma volume that travels from the exit aperture and terminates somewhere in the sur-

rounding air. The propagation velocities of plasmaplumes vary from $\sim 10^4$ to 10^5 m/s, which are several orders of magnitude higher than gas velocities^[19]. In order to obtain the plume propagation velocities, costly high-speed intensified charge-coupled device (ICCD) cameras are currently used in most of the experiments reported^[20-21]. Somehow, the price of an ICCD is pretty high, and not every plasma laboratory has an ICCD. In order to find relatively simple and cheaper method for estimating the plasma plume propagation velocity, charge method is investigated in this paper.

Experimental setup

The plasma generator is consisting a negative DC source, Blumlein-type pulse-forming network (E-PFN) and a dynamic spark gap switch. A triggered spark gap switch was used as a closing switch of E-PFN. The APPJ is consists of 4 inductor, each inductor equal $5\mu\text{H}$ and 5 capacitor each capacitor equal 5nF . A charging resistance value of $100\text{k} \ \Omega$ is chosen in the present case which corresponds to a charging RC time constant of 1.0ms . A schematic of the pulsed atmospheric-pressure plasma jet (APPJ) discharge and of the experimental set-up is shown in Figure 1. The gas is fed through an annular region between the two metal electrodes 15 cm in length. The inner electrode is 5 mm in diameter and is powered with a pulsed high voltage power supply, while the grounded outer electrode is separated from the inner electrode by a gap of a few millimeters. The APPJ device operates using $5\text{-}20\text{ kV}$

power supply with a gap between two electrodes of $2\text{-}3\text{ mm}$ under atmospheric pressure^[17]. The spark gap between rotating grounded electrode and fixed high voltage electrode is adjusted at required breakdown voltage. Hence the gap gets triggered in each rotation, which gives the repetition frequency of order 25 Hz (pulses/s). As the voltage on the capacitors reached the spark-over voltage of the spark gap electrode, the capacitors discharged, producing a high voltage pulse.

Charge method

The charge method is simple and can be used to obtain the spatially resolved plume propagation velocity by collecting charges on an equivalent capacitor. Figure 2 shows the schematic of the “charge method.” As shown in Figure 2, the plasma plume is in contact with the quartz tube. The contacting point of the plume with the quartz tube is covered by a 2-mm -wide conducting ring made of thin aluminum foil. Another conducting ring with the same width is added to the inner surface of the quartz tube opposite to the outer ring. The inner ring is connected to the ground. The charge deposited on the outer aluminum foil is obtained through integration of the current flowing through the ground wire^[19].

RESULTS AND DISCUSSION

The high voltage pulses are applied between the needle electrode positioned inside a dielectric cylinder (a simple

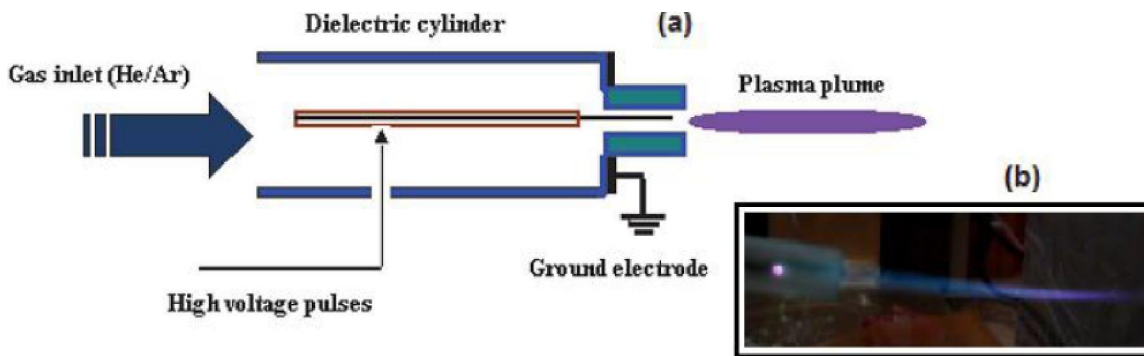

Figure 1 : (a) Schematic diagram of the plasma jet generator. (b) Image of the plasma jet with helium gas

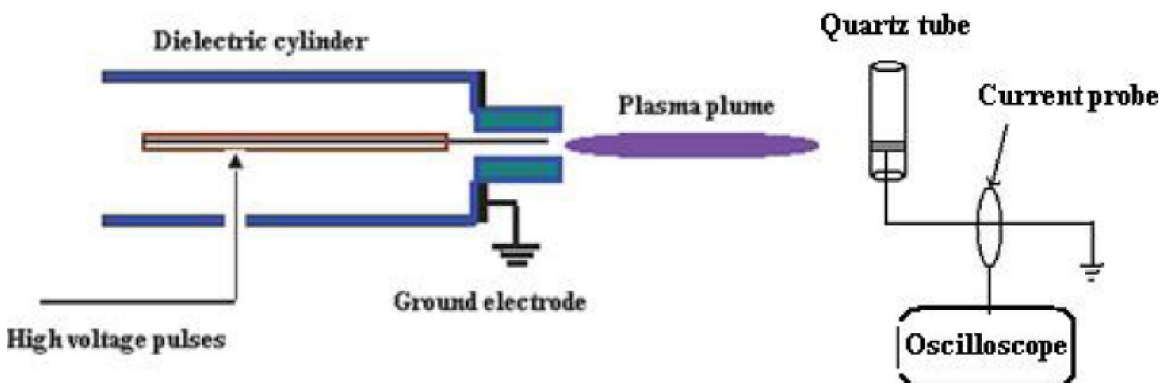

Figure 2 : Schematic of the “charge method.” The quartz tube could move along the plasma plume

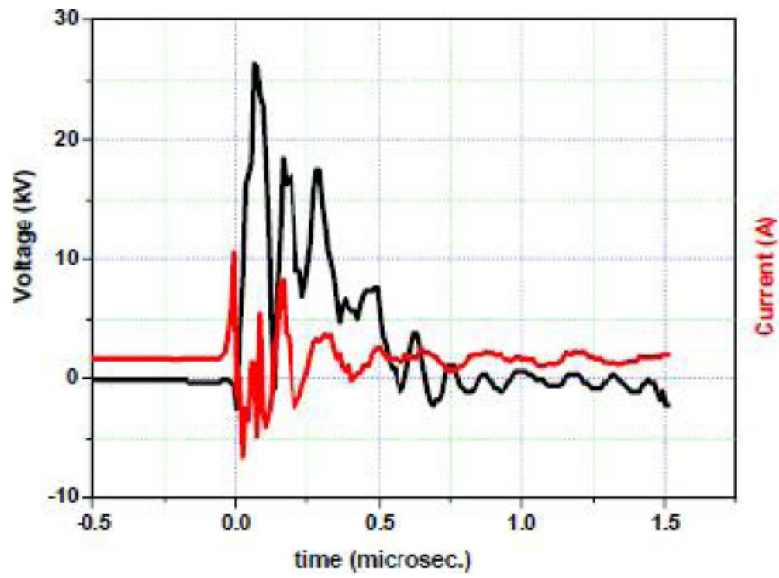

Figure 3 : Typical discharge current and the voltage waveforms

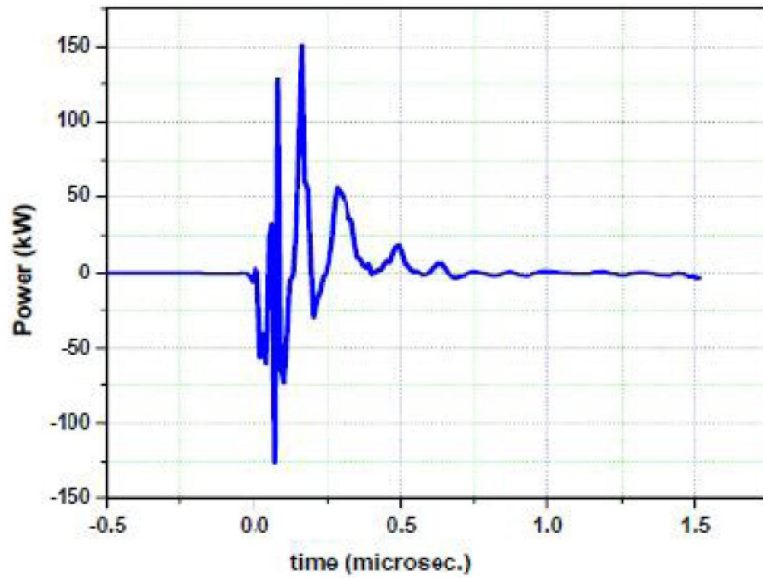

Figure 4 : The power waveform of the device

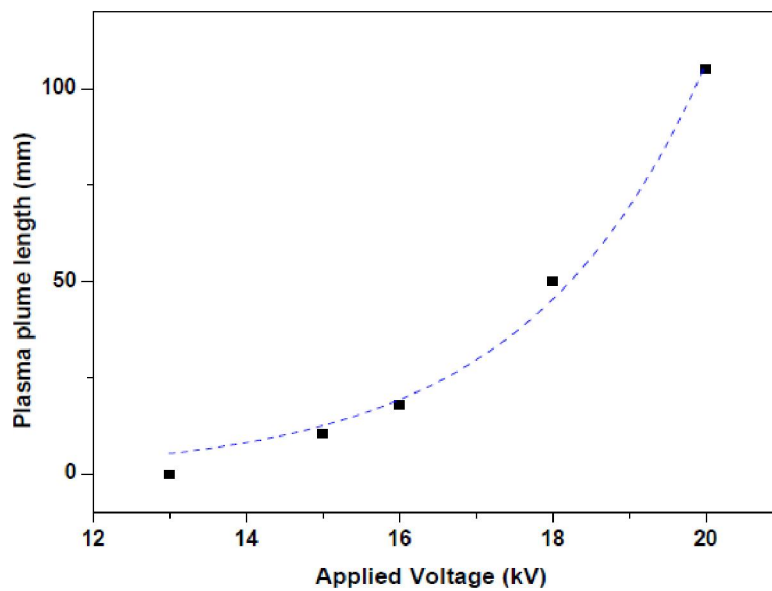

Figure 5 : Dependence of plasma plume length on applied voltage

medical syringe) and a metal ring placed on the exterior of this cylinder. In order to obtain electric discharges at atmospheric pressure, a high voltage pulses (tens of kV) which have limited duration (hundreds of nanoseconds) and are repeated (tens of pulses per second), in addition to an inert gas (helium) is introduced in the cylinder. The gas flows were in the range 0.5–10 liter per minute. The discharge takes place between the metallic needle top and a metallic ring fit on the outer surface of the syringe. Under optimal conditions, plasma is emitted as centimeter-long jets, just millimeters in diameter or even smaller.

The working gases are supplied by high-pressure cylinders. Gas pressure regulators are used to reduce the pressure of gases to a workable level. Then, gas flow controllers deliver the gases with the desired flow. For voltage amplitudes of 15–18 kV, the plasma jet is very weak.

The plasma jet disappears for voltage amplitudes lower than 15 kV. When helium is injected from the gas inlet and high voltage pulses 26 kV voltage is applied to the electrode, the plasma jet is generated and a plasma plume reaching length of 21 mm is launched through the end of the tube and in the surrounding air. The plasma has a cylindrical shape. The length of the plasma plume can be adjusted by the gas flow rate and the applied voltage.

A Lecroy 200 MS/s 4-channel digital storage oscilloscope model (9304c) was used to record voltage and current waveforms, via a high voltage probe and a pulse current transformer, respectively; and to calculate the discharge power. The measured peak value of the discharge current was approximately 10.5 A during the pulse. Figure 3 shows the current and voltage waveforms measured as a function of time at an input energy of 6.76 J (maximum

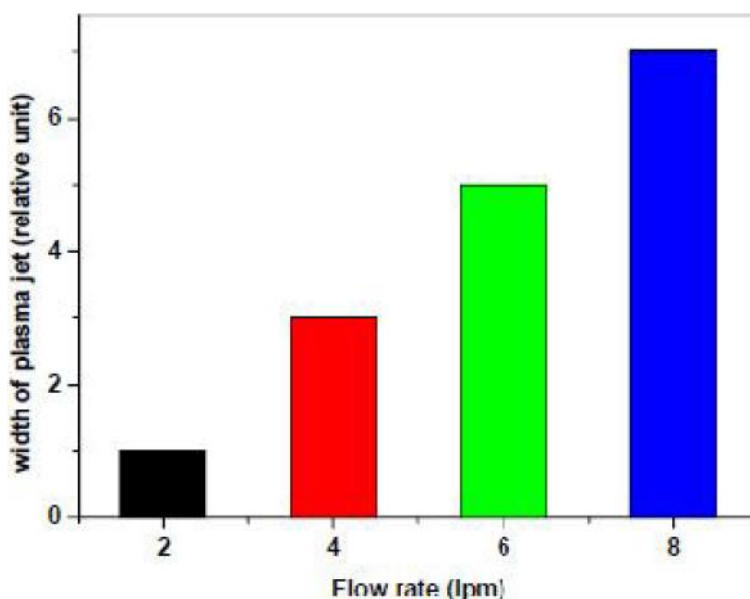

Figure 6 : Dependence of the plasma jet width on helium flow rate

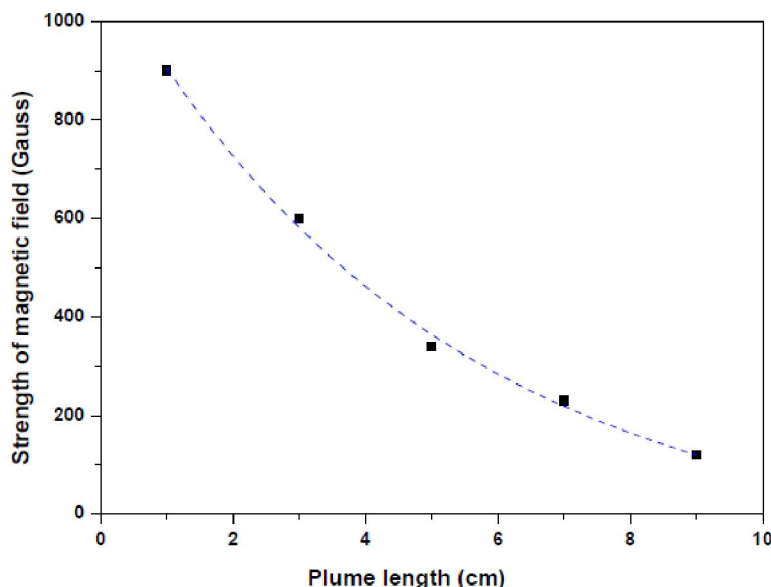

Figure 7 : The peak value of the magnetic field strength for different plume length (probe is mounted 3cm below the plasma plume)

applied voltage 26 kV). Figure 4 shows the power input as a function of time, the maximum power approximately 150 kW at time 167 ns.

Figure 5. indicates the dependence of plasma plume length on applied voltage. As the result with increasing applied voltage, the plume length increase exponentially. It is found that the maximum plasma plume length about 105 mm at 20 kV of applied voltage and there is no plasma plume in open air at 13 kV of applied voltage.

Figure 6 indicates the dependence of the plasma jet width on helium flow rate, the minimum width at 2 liter per minute and maximum at 8 liter per minute. With increase gas flow rate, discharge voltage increased. This is because a higher energy is necessary to get larger amounts

of gas into excited states.

The Model 5080 Gauss/Tesla-meter is a portable instrument that utilizes a Hall probe to measure magnetic flux density (magnetic field strength) in terms of gauss, tesla or ampere-meter is used to measure the magnetic field radiated by the plasma plume. The magnetic field probe is mounted 3cm and 5cm below the plasma plume to avoid disturbing the discharge. The magnetic field probe is used to measure the magnetic field strength at different distances along the plasma plume. Essentially, the magnetic field radiated by the plasma plume is caused by the transient current pulse, which is mainly electron current since electrons move much faster than ions due to the difference of their mass. Thus, the current carried by the plasma plume

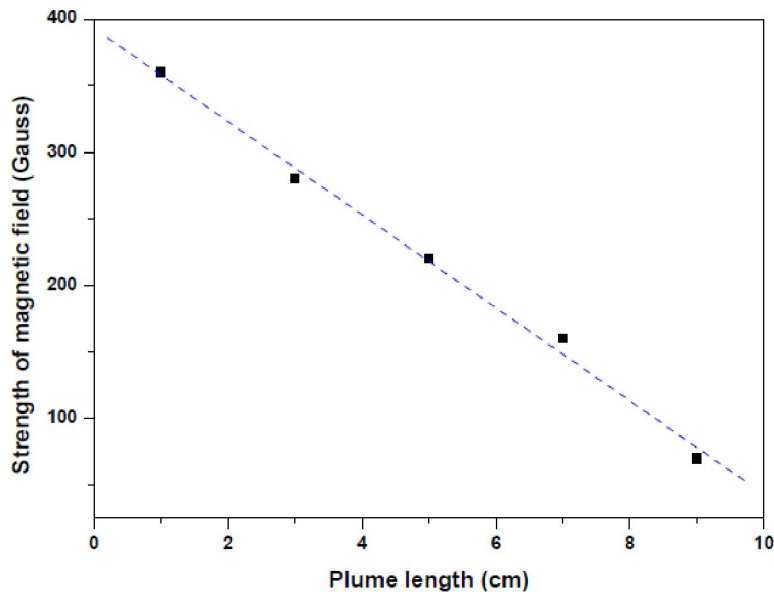

Figure 8 : The peak value of the magnetic field strength for different plume length (probe is mounted 5cm below the plasma plume)

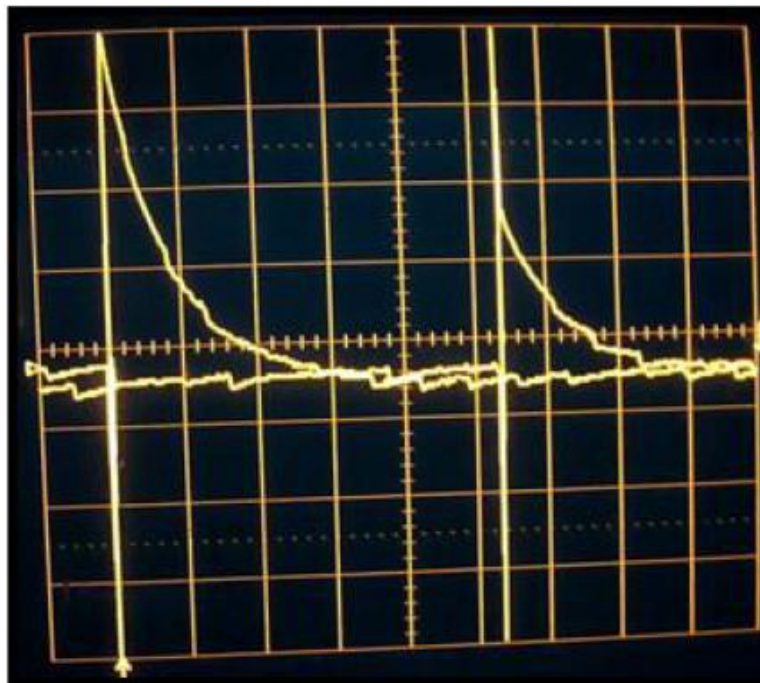

Figure 9 : Plume currents at 2cm (left signal) and 5cm (right signal) from the nozzle versus time (0.1 μs/division).

can be determined through the measurement of the magnetic field accordingly. For the magnetic field strength is sensitive with the probe axis orientation and distance from the current axis, the magnetic field probe is installed at different locations below plasma plume. Figure 7 shows the peak value of the magnetic field strength about 900 gauss at 1 cm away from the nozzle (3 cm below the plasma plume) and decrease along the plume length. Also, Figure 8 shows the peak value of the magnetic field strength at different distance away from nozzle (5 cm below the plasma plume), the maximum magnetic field about 360 gauss at 1 cm from nozzle.

The charge method is used directly to estimate the velocity of the plasma bullet. When the plasma plume is in contact with the aluminum foil, as shown in Figure 2, the charges carried by the plume are deposited on the aluminum foil surface. The charge deposited on the foil surface can be measured through the current probe. The two typical current waveforms correspond to the quartz tube placed at 2 and 5 cm away from the nozzle. According to Figure 9, the average velocity of the plasma bullets is estimated to be about 5.5×10^6 cm/s. It should be emphasized that when the quartz tube is placed too close to the nozzle, the discharge is affected by the tube, and it probably affects the plasma plume propagation velocity.

CONCLUSION

It is found that the cold plasma jet using helium gas generated under atmospheric pressure by means of high voltage pulsed power generator radiates magnetic field. The magnetic field radiated from the plasma plume is measured by Hall probe to measure magnetic field strength in terms of gauss. By placing Hall probe at different position along the plasma plume, the magnetic field strength decrease away from the nozzle. It's found that the maximum value of the magnetic field strength about 900 gauss at 1 cm away from the nozzle. The average velocity of the plasma bullets is estimated to be about 5.5×10^6 cm/s using charge method.

REFERENCES

- [1] R.M.Shakaran, K.P.Giapis; *Appl.Phys.Lett.*, **79**, 593 (2001).
- [2] J.Benedikt, K.Focke, A.Yanguas Gil, A.Von Keudell; *Appl.Phys.Lett.*, **89**, 251504 (2006).
- [3] S.J.Park, K.S.Kim, and J.G.Eden; *Appl.Phys.Lett.*, **86**, 221501 (2005).
- [4] A.Rahman, A.P.Yalin, V.Surla, O.Stan, K.Hoshimiya, Z.Yu, E.Littlefield, G.J.Collins; *Plasma Sources Sci.Technol.*, **13**, 537 (2004).
- [5] K.Hensel, S.Katsura, A.Mizuna; *IEEE Trans.Plasma.Sci.*, **33**, 574 (2005).
- [6] Ahmed A.Aly, G.M.El-Aragi; Comparison between gamma irradiation and plasma technology to improve the safety of cold sliced chicken, *African Journal of Food Science*, **7(12)**, 461-467, December, (2013).
- [7] Ahmed A.Aly, G.M.El-Aragi; Effects of gamma irradiation and plasma technology on some chemical properties of camel meat, *ChemXpress*, **6(4)**, (2014).
- [8] A.Schutze, J.Y.Jeong, S.E.Babayana, J.Park, G.S.Selwin, R.F.Hicks; *IEEE Trans.Plasma Sci.*, **26**, 1685 (1998).
- [9] K.Niemi, Sh.Wang, V.Schultz-Von Der Gathen, H.F.Dböele; Poster Conference *Frontiers on Low Temperature Plasma Diagnostics*, Lecce Italy, Available online: <http://ftpd-5.ba.cnr.it/Paper/Libro/239.pdf>, (2003).
- [10] E.Stoffels, A.J.Flikweert, W.W.Stoffels, G.M.W.Kroesen; *Plasma Sources Sci.Technol.*, **11**, 383 (2002).
- [11] J.Janca, L.Zajickova, M.Klima, P.Slavicek; *Plasma Chem.Plasma Proc.*, **21**, 565 (2001).
- [12] M.Laroussi, C.Tendero, X.Lu, S.Alla, W.L.Hynes; *Plasma Process.Polym.*, **3**, 470 (2006).
- [13] V.Léveillé, S.Coulombe; *Plasma Sources Sci.Technol.*, **14**, 467 (2005).
- [14] J.R.Roth, D.M.Sherman, R.Ben Gadri, F.Karakaya, Z.Chen, T.C.Montie, K.Kelly-Winterberg, P.P.Y.Tsai; *IEEE Trans.Plasma Sci.*, **28**, 56 (2001).
- [15] M.Laroussi, I.Alexeff, J.P.Richardson, F.F.Dier; *IEEE Trans.Plasma Sci.*, **30**, 158 (2002).
- [16] S.Kanazawa, M.Gogoma, T.Moriwaki, S.Okazaki; *J.Appl.Phys.D: Appl.Phys.*, **21**, 838 (1988).
- [17] G.M.El-Aragi, Abdel Monsef A.Elhadry, M.M.Ahmed, S.A.Montaser; Cytogenetic and immunological effects resulting from cold pulsed atmospheric pressure plasma jet exposure on human blood cultures, *Plasma Medicine*, **2(4)**, 191-205 (2012).
- [18] G.M.El-Aragi, Abdel monsef A.Elhadry, M.M.Ahmed, Z.S.Said; Promising trial for treatment of chronic myelogenous leukemia using plasma technology, *Plasma Medicine*, **3(4)**, 243-265 (2013)
- [19] Zilan Xiong et al.; Measurements of the Propagation Velocity of an Atmospheric-Pressure Plasma Plume by Various Methods, *IEEE transactions on plasma science*, **38(4)**, April, (2010).
- [20] B.Sands, B.Ganguly, K.Tachibana; "A streamer-like atmospheric pressure plasma jet", *Appl.Phys.Lett.*, **92(15)**, 151 503, Apr., (2008).
- [21] X.Lu, M.Laroussi; "Dynamics of an atmospheric pressure plasma generated by submicrosecond voltage pulses", *J.Appl.Phys.*, **100(6)**, 063 302, Sep., (2006).